

This manual applies to Series A AlphaEclipse 3600 signs.

To find out if you have a Series A sign, see the "Series letter" in "Equipment identification" on page 10.

INSTALLATION CHECKLIST

Done?	#	Description	Reference
	1	Determine required number and amperage of sign power circuits.	"Equipment identification" on page 10.
	2	For a sign using a wireless transceiver, conduct a site survey to determine where to locate the wireless transceiver that will send messages to the sign.	Contact Adaptive Technical Support.
	3	Mount sign.	"Mechanical installation" on page 12. (For a multiple-section sign, see "Shop drawings" on page 37.)
	4	Determine <i>sign-to-sign</i> connection method to be used (multiple sign installation only): <input type="checkbox"/> Master/Master <input type="checkbox"/> Master/Secondary Master <input type="checkbox"/> Master/Slave	"Sign-to-sign connections" on page 21. "Serial address of a sign" on page 31.
	5	Connect <i>sign-to-sign</i> communication wire (multiple sign installation only).	"Sign-to-sign connections" on page 21.
	6	Determine <i>sign-to-computer</i> connection method to be used (identify which sign): <input type="checkbox"/> Wired (RS485): sign serial address _____ <input type="checkbox"/> Modem: sign serial address _____ <input type="checkbox"/> Wireless transceiver: sign serial address _____ <input type="checkbox"/> Fiber optic cable: sign serial address _____	"Computer-to-sign connections" on page 25.
	7	For a sign using a wired (RS485) or a fiber optic cable, connect <i>sign-to-computer</i> communication wire.	"Computer-to-sign connections" on page 25.
	9	Install temperature probe (optional).	"Temperature probe mounting (optional)" on page 15.
	9	Check termination of each sign.	"RS485 termination" on page 34.
	10	Connect power and ground to the sign.	"Electrical installation" on page 16.

© Copyright 2003-2004 Adaptive Micro Systems LLC. All rights reserved.

Adaptive Micro Systems • 7840 North 86th Street • Milwaukee, WI 53224 USA • 414-357-2020 • 414-357-2029 (fax) • <http://www.adaptivedisplays.com>

Trademarked names appear throughout this document. Rather than list the names and entities that own the trademarks or insert a trademark symbol with each mention of the trademarked name, the publisher states that it is using names for editorial purposes and to the benefit of the trademark owner with no intention of improperly using the trademark.

The following are trademarks of Adaptive Micro Systems: Adaptive, Alpha, AlphaLert, AlphaNET, AlphaNet plus, AlphaEclipse, AlphaPremiere, AlphaTicker, AlphaVision, AlphaVision InfoTracker, Automode, BetaBrite, BetaBrite Director, BetaBrite Messaging Software, Big Dot, Director, EZ KEY II, EZ95, PagerNET, PPD, PrintPak, Serial Clock, Smart Alec, Solar, TimeNet.

The distinctive trade dress of this product is a trademark claimed by Adaptive Micro Systems LLC.

Due to continuing product innovation, specifications in this manual are subject to change without notice.

Contents

Introduction	4
Revision history	4
Related documentation	4
Safety	5
Warnings and cautions	5
Battery backup	5
Equipment overview	6
Description	6
Front and top views	6
Back and side views	7
Internal view	8
Equipment identification	10
Temperature protection	11
Equipment symbols	11
Preventing electrostatic discharge damage	11
EMI compliance	11
Installation	12
Mechanical installation	12
Overview	12
Support structure design	12
Ventilation requirements	12
Lifting the sign	14
Temperature probe mounting (optional)	15
Electrical installation	16
Guidelines for electrical installation	16
Run power to the sign	16
Ground the sign	18
Networking	21
Sign-to-sign connections	21
Master/Master sign wiring	22
Master/Secondary Master sign wiring	23
Master/Slave sign wiring	24
Computer-to-sign connections	25
RS485 wire computer-to-sign connection	26
Modem computer-to-sign connection	27

- Fiber optic computer-to-sign connection 28
- Wireless transceiver computer-to-sign connection (Locus) 29
- Wireless transceiver computer-to-sign connection (Alpha RF900) 30
- Appendix 31
 - Serial address of a sign 31
 - Opening a sign 32
 - How to open a sign from the back 32
 - How to open a sign from the front 33
 - RS485 termination 34
 - What is RS485 termination? 34
 - When is termination used? 34
 - How to terminate a sign 35
 - Shop drawings 37
 - Single cube wiring diagram (11800000-04, revision C) 38
 - Right wireway multi-cube wiring diagram (11800000-05, revision E, sheet 1 of 2) 40
 - Right wireway multi-cube wiring diagram (11800000-05, revision E, sheet 2 of 2) 42
 - Mechanical installation (11800000-07 revision F, sheet 1 of 5) 44
 - Mechanical installation (11800000-07 revision F, sheet 2 of 5) 46
 - Mechanical installation (11800000-07 revision F, sheet 3 of 5) 48
 - 120V electrical installation (11800000-07 revision F, sheet 4 of 5) 50
 - 230V electrical installation (11800000-07 revision F, sheet 5 of 5) 52
 - Multi-section sign: vertical split assembly (11800000-15, revision A) 54
 - Multi-section sign: horizontal split assembly (11800000-16, revision A) 56
 - Multi-section sign: vertical/horizontal split assembly (11800000-17, revision A, sheet 1 of 2) 58
 - Multi-section sign: vertical/horizontal split assembly (11800000-17, revision A, sheet 2 of 2) 60
 - Left wireway multi-cube wiring diagram (11800000-22, revision B, sheet 1 of 2) 62
 - Left wireway multi-cube wiring diagram (11800000-22, revision B, sheet 2 of 2) 64

Introduction

Revision history

Revision	Date	Notes
9711-8001	June 24, 2003	First release.
9711-8001A	November 25, 2003	Adaptive logo and trademark information updated.
9711-8001B	March 8, 2004	Corrected "Adaptive Explains" on page 20.
9711-8001C	September 28, 2004	Added information on Secondary Master sign connections and revised section on multiple section signs.

Related documentation

Part #	Manual title	Description
9708-8081	AlphaNET Version 3.0 User Manual	Explains the software used to create and send messages to the sign.
9711-8010	AlphaEclipse 3600 AC Distribution Board Part Replacement	Describes how to replace AlphaEclipse 3600 sign AC distribution boards.
9711-8011	AlphaEclipse 3600 Controller + 4-Channel Turbo Driver Board Part Replacement	Describes how to replace an AlphaEclipse 3600 sign controller board that has an 4-channel turbo board.
9711-8012	AlphaEclipse 3600 Red LED Driver Board Part Replacement	Describes how to replace AlphaEclipse 3600 sign LED driver boards.
9711-8013	AlphaEclipse 3600 Amber LED Driver Board Part Replacement	
9711-8014	AlphaEclipse 3600 RGB LED Driver Board Part Replacement	
9711-8015	AlphaEclipse 3600 RS485 Terminator Part Replacement	Describes how to replace AlphaEclipse 3600 sign terminators.
9711-8016	AlphaEclipse 3600 Light Sensor Board Part Replacement	Describes how to replace an AlphaEclipse 3600 sign light sensor board.
9711-8017	AlphaEclipse 3600 Controller + 8-Channel Turbo Driver Board Part Replacement	Describes how to replace an AlphaEclipse 3600 sign controller board that has an 8-channel turbo board.
9711-8018	AlphaEclipse 3600 Turbo Adapter Board Part Replacement	Describes how to replace AlphaEclipse 3600 sign turbo adapter boards.
9711-8020	AlphaEclipse 3600 Power Supply Part Replacement	Describes how to replace AlphaEclipse 3600 sign power supplies.
9711-8021	AlphaEclipse 3600 120V Fan Part Replacement	Describes how to replace AlphaEclipse 3600 sign cube fans.
9711-8022	AlphaEclipse 3600 240V Fan Part Replacement	

Safety

Warnings and cautions



Other warnings and cautions are posted in appropriate locations throughout this manual.

Battery backup

In the event of power loss, backup batteries in an AlphaEclipse sign provide power in order to save messages and time settings.

A backup battery is located on the top of a sign's controller board under the turbo driver board (the dashed line below). The backup battery should only be replaced by a qualified Adaptive technician:

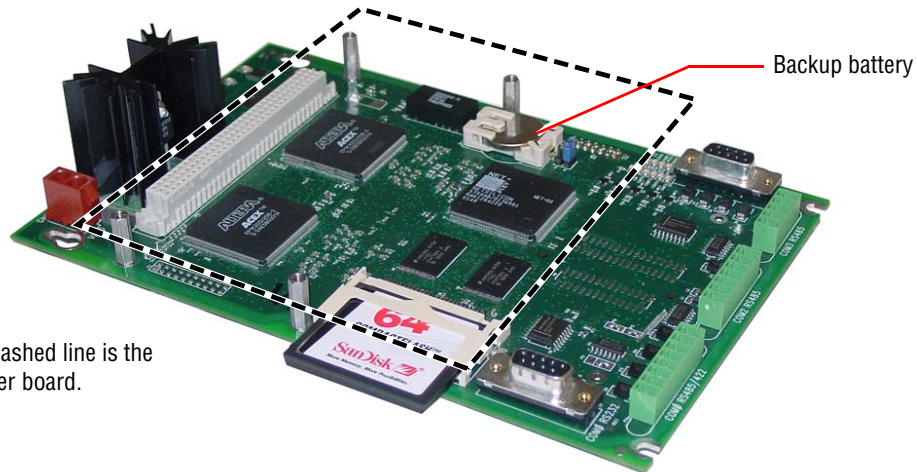

Controller board — the dashed line is the location of the turbo driver board.

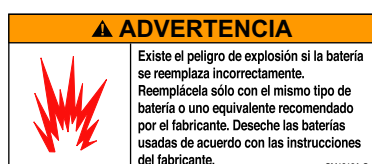
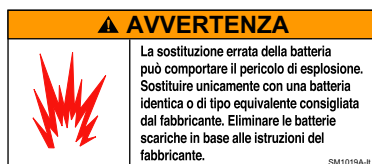
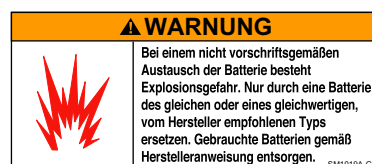
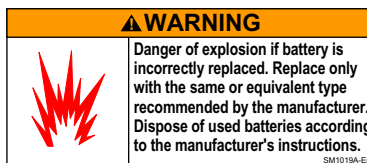

Equipment overview

Description

Front and top views

Shown below is a 64 x 32 pixel sign with the wireway on the right side of the sign. Other sign sizes are similar.

Top view

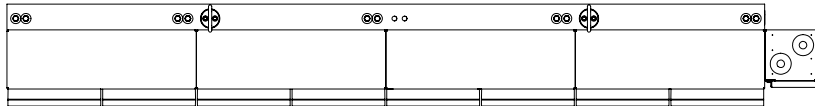

Front view

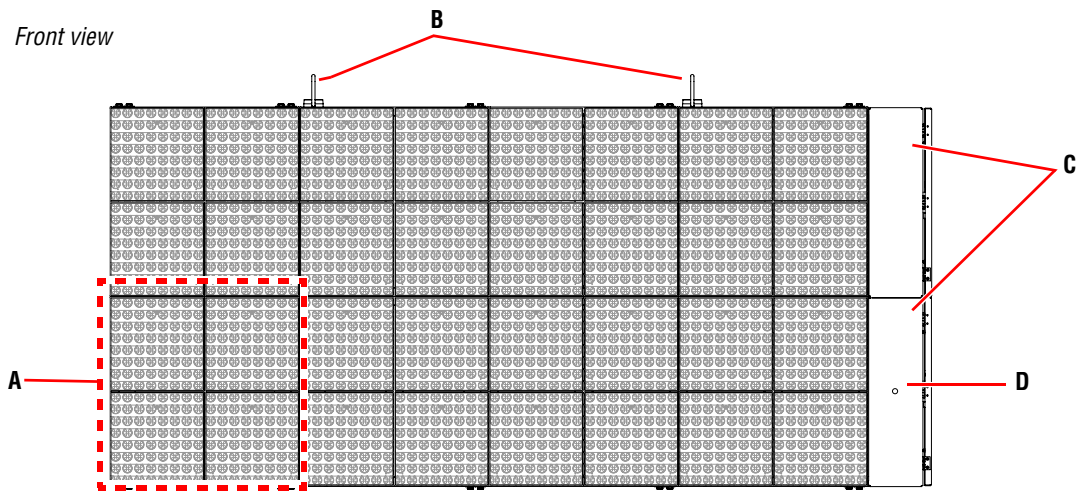

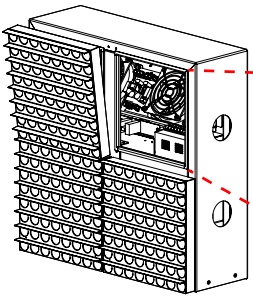
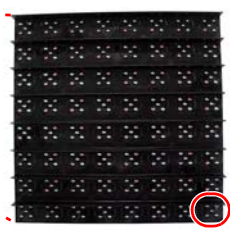
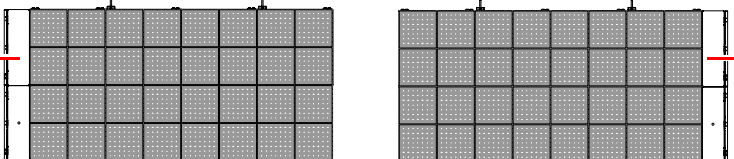
Item	Name	Description
A	Cube	<p>Consists of four LED modules:</p> <p>Each LED module can be removed from the front of the sign.</p>  <p>Each LED module is 8 pixels tall by 8 pixels wide (8 x 8). So each cube is 16 x 16 pixels.</p>  <p>A single LED pixel.</p>
B	Lifting hooks	Used to lift the sign during installation. These hooks should be removed after the sign is installed.
C	Wireways	<p>Used to route power and communication wires to all the LED modules. Wireways may be mounted on either the left or the right side of a sign:</p>  <p>Left side wireway</p> <p>Right side wireway</p>
D	Light sensor hole	Allows light into the light sensor. This opening should be kept free of obstructions.

Back and side views

Shown below is a 64 x 32 pixel sign with the wireway on the right side of the sign. Other sign sizes are similar.

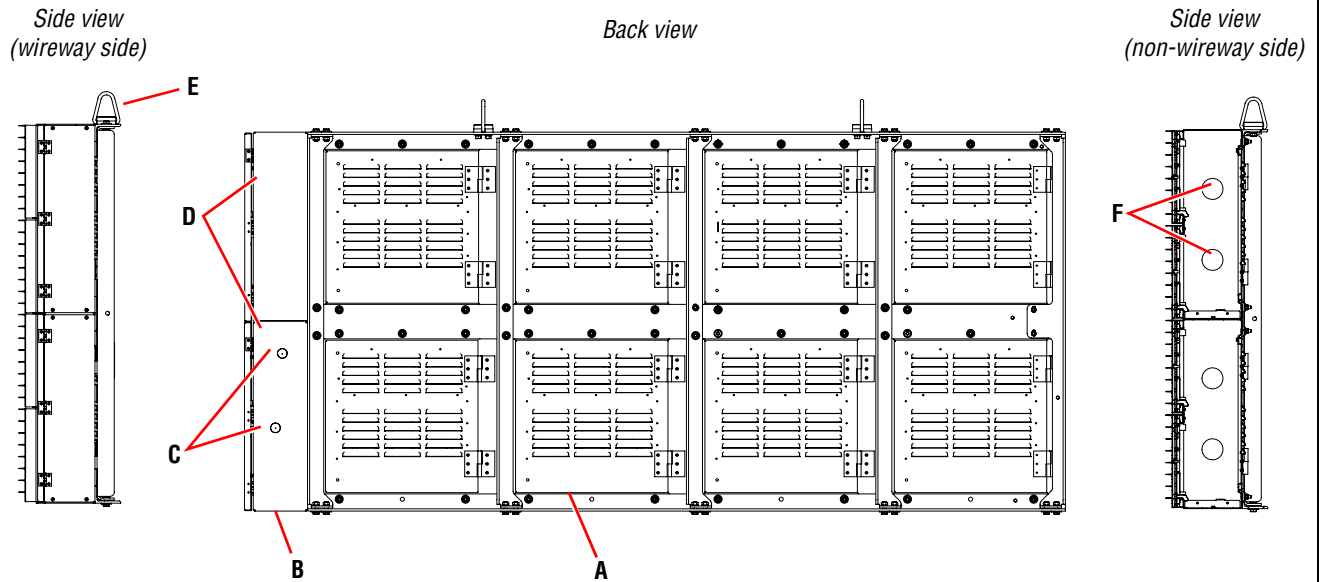

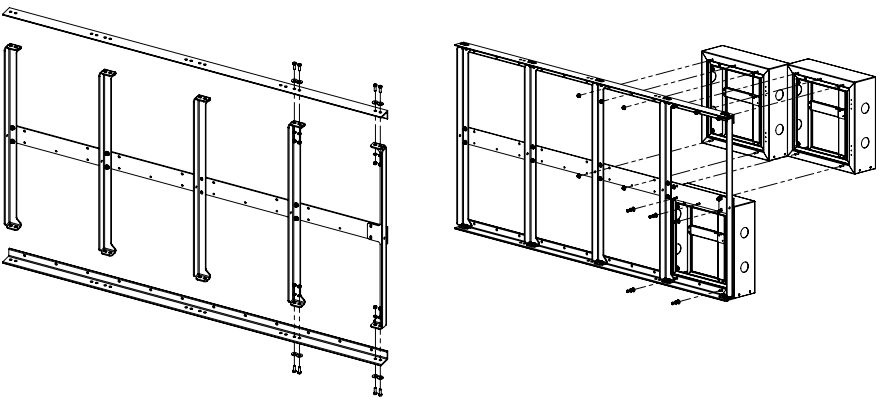
Item	Name	Description
A	Cube support frame	Each cube is attached to the cube support frame: 
B	Conduit holes	Four punchout holes located on the bottom of the wireway. These holes can be used to attach conduit in order to route power and communication wires to the sign.
C	Optional conduit holes	Locations where up to 1.38-inch conduit holes can be drilled.
D	Wireways	Used to route power and communication wires to all the LED modules.
E	Lifting hook	Used to lift the sign during installation. These hooks should be removed after the sign is installed.
F	Wireway connection holes	Used to route power and communication wires between each LED module.

Internal view

Shown below is a 64 x 32 pixel sign. Other sign sizes are similar.

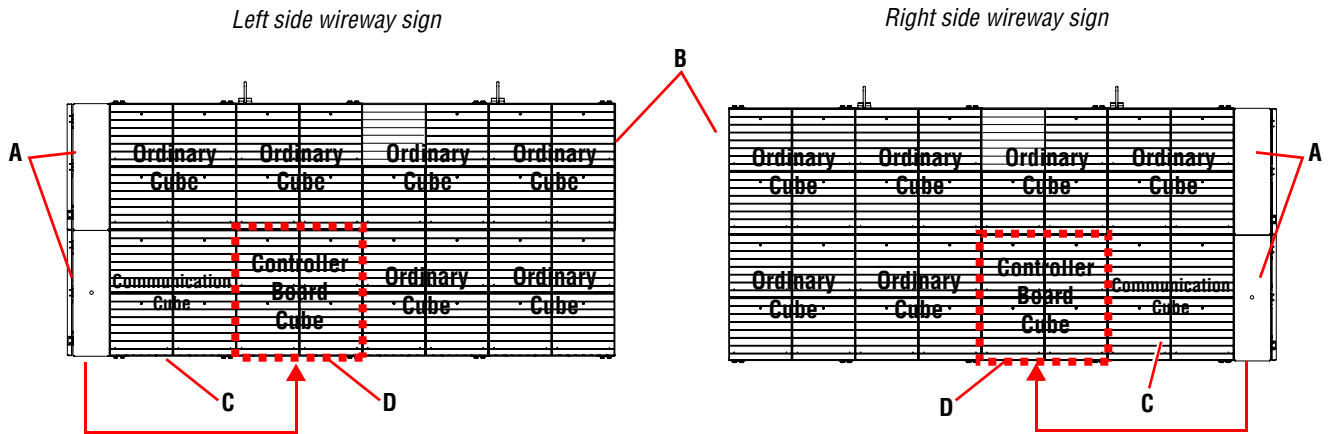

The controller board cube is always on the bottom row and the second cube from the wireway. There is one controller board cube in a sign.
 The communication cube is always on the bottom row next to the wireway. There is one communication cube in a sign.

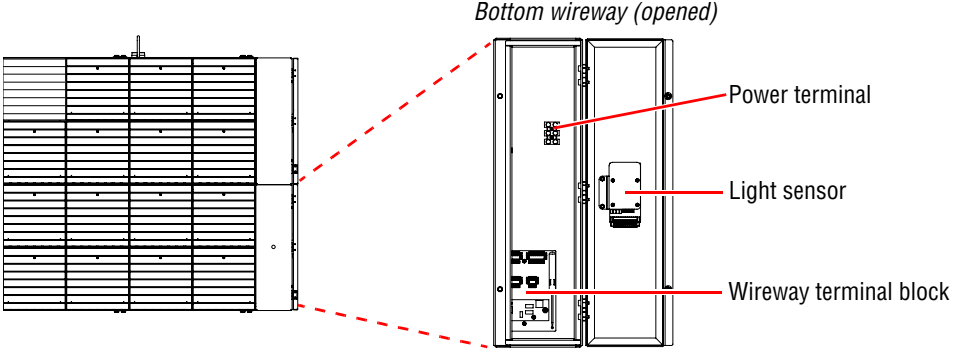
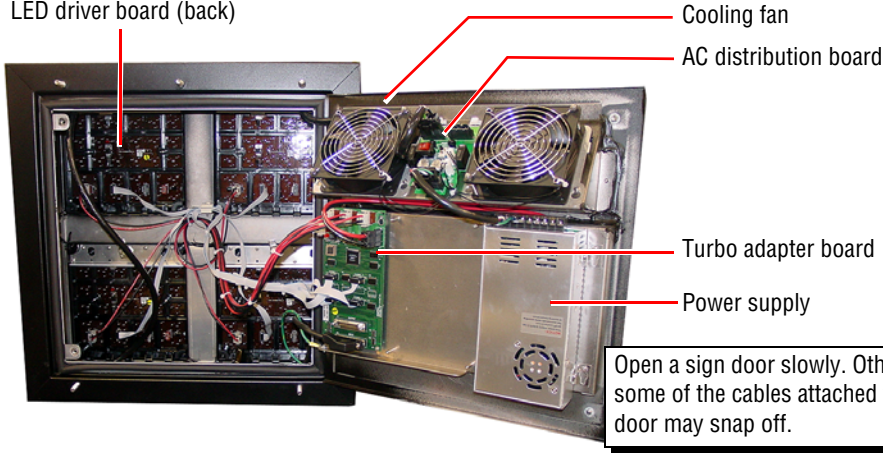
Item	Name	Description
A	Wireway	Used to route power and communication wires to all the LED modules. Wireways can be mounted on either the left or right side of a sign. The bottom wireway (shown below) contains the light sensor, wireway terminal block, and the power terminal block: 
B	Ordinary cube	The parts inside an ordinary cube can be accessed by either removing the four LED modules from the front of the cube or by opening the back of the cube (shown below):  <div data-bbox="1101 1816 1458 1921" style="border: 1px solid black; padding: 5px;"> Open a sign door slowly. Otherwise some of the cables attached to the door may snap off. </div>

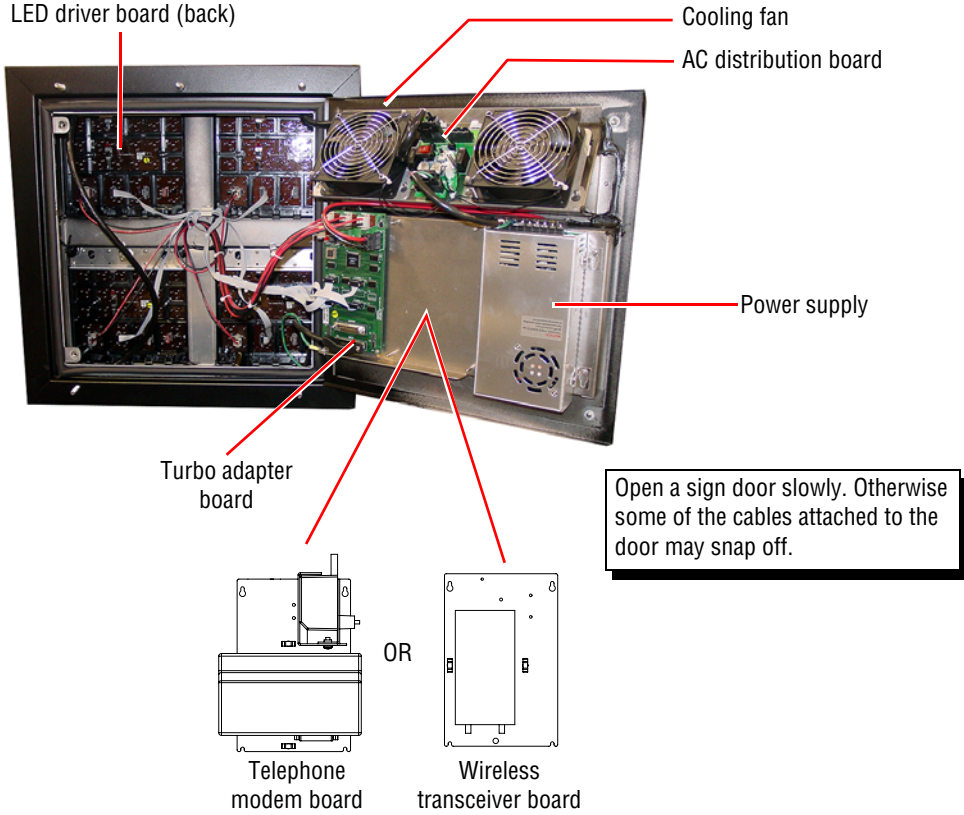
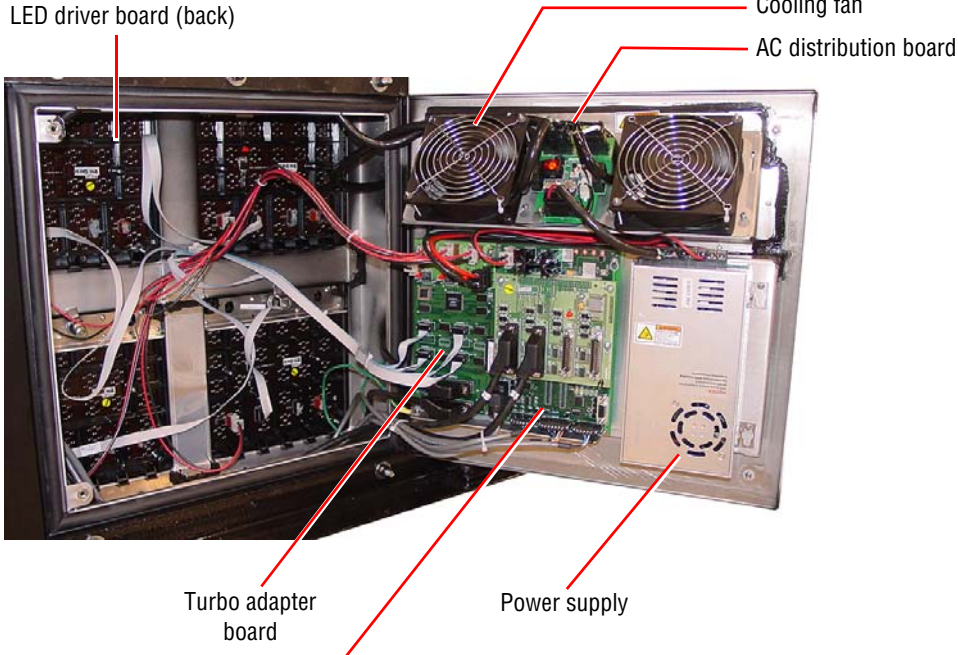
<p>C</p>	<p>Communication cube</p>	 <p>LED driver board (back)</p> <p>Cooling fan</p> <p>AC distribution board</p> <p>Power supply</p> <p>Turbo adapter board</p> <p>Telephone modem board</p> <p>OR</p> <p>Wireless transceiver board</p> <p>Open a sign door slowly. Otherwise some of the cables attached to the door may snap off.</p>
<p>D</p>	<p>Controller board cube</p>	<p>The parts inside a controller board cube can be accessed by either removing the four LED modules from the front of the cube or by opening the back of the cube (shown below):</p>  <p>LED driver board (back)</p> <p>Cooling fan</p> <p>AC distribution board</p> <p>Turbo adapter board</p> <p>Power supply</p> <p>Controller board + 4- or 8-channel turbo driver board</p> <p>Open a sign door slowly. Otherwise some of the cables attached to the door may snap off.</p>

Equipment identification

Equipment identification labels and warning labels (such as high voltage) are located inside the sign.

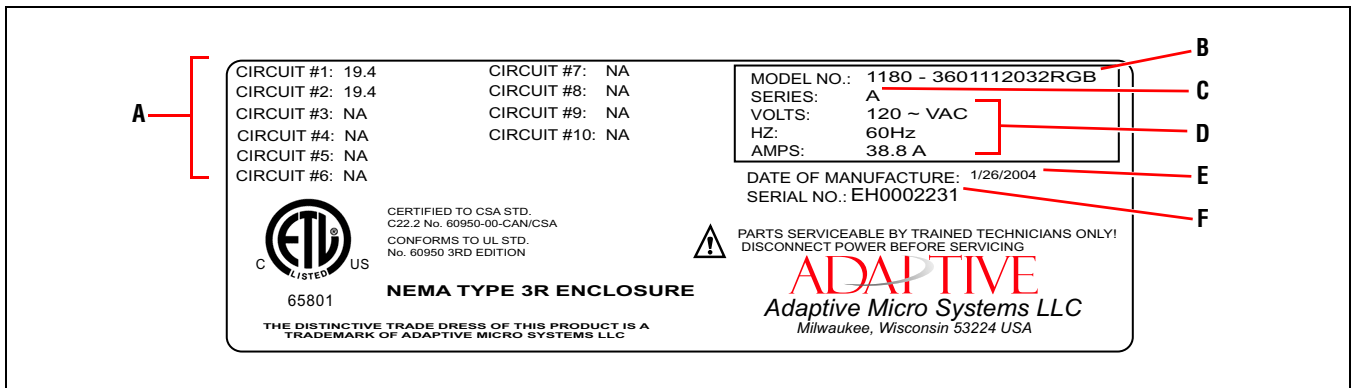

Item	Name	Description
A	Required electrical circuits	Number of electrical circuits and the amount of amperage per circuit required to power the sign.
B	Model number	<p>1180 - 3601112032RGB</p> <ul style="list-style-type: none"> LED lamp color: <ul style="list-style-type: none"> • RGB = red, green, blue • RED = red • AMB = amber Height of sign in pixels Length of sign in pixels LED viewing angle: <ul style="list-style-type: none"> • 3600 = 30 degrees • 3601 = 70 degrees Model series
C	Series letter	Revision level of sign.
D	Electrical information	Input voltage, frequency, and total amperage of sign.
E	Date of manufacture	Month, day, and year the sign was made.
F	Serial number	Consecutive, unique identification number.

Temperature protection

If the temperature inside of a sign cube exceeds . . .

- 110°F (43°C) — the cube's fans will start. When the temperature falls below 80°F (27°C), the fans will stop.
- 170°F (77°C) — power is removed from cube components except the fans. When the temperature falls below 140°F (60°C), power will be applied again.

Equipment symbols



Chassis ground



Power (I = On, 0 = Off)

Preventing electrostatic discharge damage



This equipment contains components that may be damaged by “static electricity”, or electrostatic discharge. To prevent this from happening, be sure to follow the guidelines in Adaptive Tech Memo 00-0005, “*Preventing Electrostatic Discharge (ESD) Damage*,” available on our Web site at <http://www.adaptivedisplays.com>.

EMI compliance

This equipment has been tested and found to comply with the limits for a Class A digital device, pursuant to Part 15 of the FCC Rules. These limits are designed to provide reasonable protection against harmful interference when the equipment is operated in a commercial environment.

This equipment generates, uses, and can radiate radio frequency energy and, if not installed and used in accordance with installation guidelines, may cause harmful interference to radio communications. Operation of this equipment in a residential area is likely to cause harmful interference, in which case the user will be required to correct the interference at his own expense.

Installation

NOTE: For sign that are shipped in multiple sections and must be assembled before installing, see “Shop drawings” on page 37.

Mechanical installation

Overview

Because every sign installation is unique, there is no single procedure for mounting AlphaEclipse 3600 signs.

This section is only intended as a guide. A set of sign shop drawings is located at the end of this manual. These drawings should aid in most any type of installation.

All installations, superstructure designs, and connections must be designed and approved by a qualified structural engineer. Call Adaptive Micro Systems at 1-800-558-7022 for contact information for structural engineering consultants.

- Drill holes as needed in the sign’s steel framework for fasteners, but consult the attached shop drawings for excluded areas. *Drilling holes in any of these excluded areas will void the sign’s warranty.* When drilling holes, follow these guidelines:
 - Connections must be analyzed by a structural engineer.
 - Dissimilar metals should be isolated to avoid galvanic corrosion.
- Any area on the sign’s frame that had paint removed during mounting must be recoated with a paint recognized by UL test #1332. *Failure to repaint the area will result in accelerated corrosion of the sign’s structure. Adaptive Micro Systems is not responsible for any failure in the sign’s structure because of this.* (POLANE HS Plus Polyurethane Enamel is used to paint the sign’s frame during manufacturing.)

Support structure design

The design of a sign’s support structure depends on a number of factors:

- mounting methods
- building codes
- foundation
- sign size
- sign weight
- sign height
- wind loading

Ventilation requirements

If the sign is mounted to a solid surface like a wall, then nothing should block the space between the top, bottom, and sides of the sign and the solid surface.

If there is an obstruction (as in a monument-style installation), then run duct work (not supplied) from the bottom side of the sign and laterally to the top of the sign to exhaust hot air. Be sure no rain or snow can enter the sign through this duct work. To avoid heat build-up and depending on sign size, more space may be required at the back of the sign to provide ample air flow. Fans can be used to supplement natural air flow. Adaptive Micro Systems recommends isolating the fresh air intakes from the exhaust air.

Multiple section sign assembly

Very large AlphaEclipse 3600 signs will be shipped from the factory in multiple sections. Multiple section signs are assembled in one of three ways:

Vertical split assembly

See "Multi-section sign: vertical split assembly (11800000-15, revision A)" on page 54.

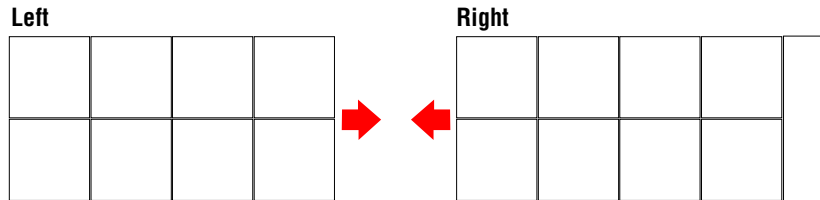

Horizontal split assembly

See "Multi-section sign: horizontal split assembly (11800000-16, revision A)" on page 56.

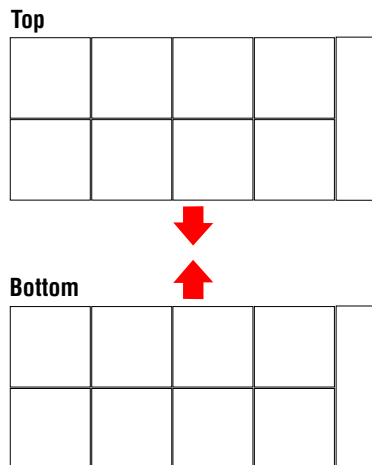

Vertical and horizontal split assembly

See "Multi-section sign: vertical/horizontal split assembly (11800000-17, revision A, sheet 1 of 2)" on page 58.

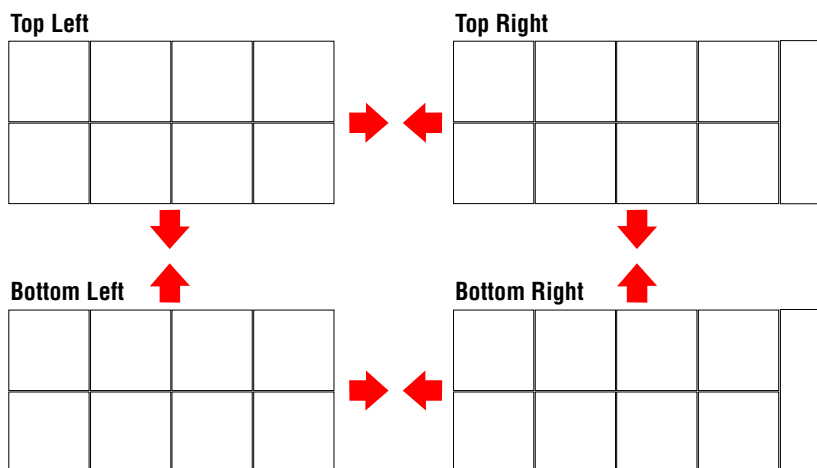

Lifting the sign

Use the two lifting hooks on the sign with a lifting bar to raise the sign:

NOTE: After mounting the sign, remove the lifting hooks.

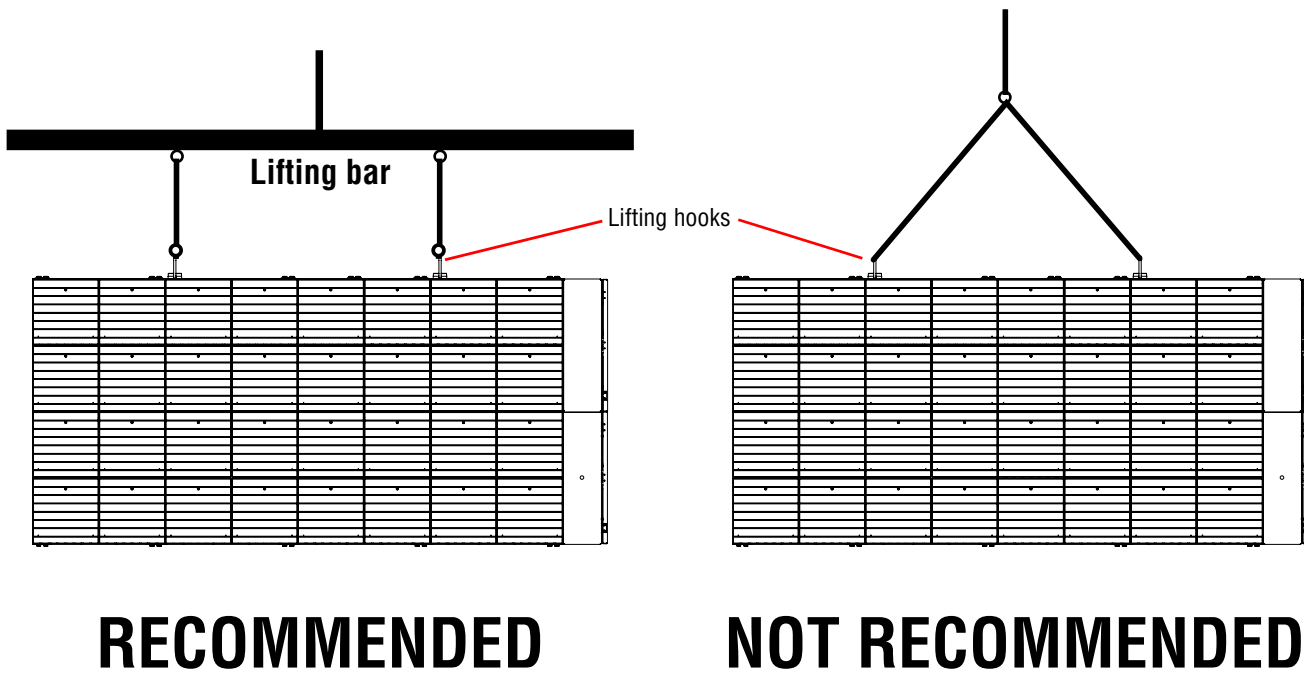
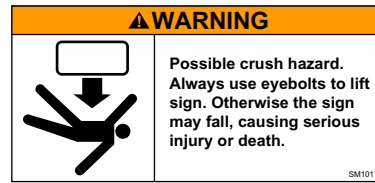
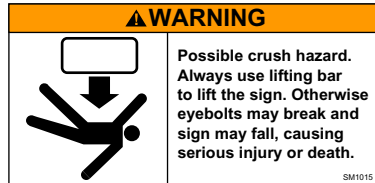
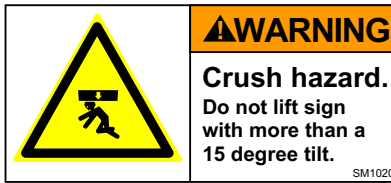

Figure 1: Sign lifting methods

Temperature probe mounting (optional)

NOTE: Complete this section only if your sign is equipped with a temperature probe.

NOTE: For two or more signs connected as Master/Master (page 22), attach a temperature probe to *each* sign. For two or more signs connected as Master/Secondary Master (page 23) or Master/Slave (page 24), connect a single temperature probe to *just* the Master sign.

Mounting guidelines

- Choose a location where air movement is not restricted by nearby walls or other obstructions. A light-colored background is preferable to a dark-colored mounting background. A location above vegetation is preferable to a location above asphalt or blacktop.
- Mount the temperature probe at least one foot below the eave of a protected overhang so convection currents (rising hot air flow) are not trapped around the temperature probe. Also, make sure convection currents are not blocked by the mounting plates.
- A location on the north side of a building or other large structure will afford protection from the afternoon sun. Mount the temperature probe at least 6 feet off the ground. Shield the probe from the effect of the direct sun, reflected heat, or any nearby sources of heat, such as chimneys, vents, or HVAC ducts.

Installation

1. Mount the temperature probe vertically using the mounting plate on each side of the probe. The temperature probe can be mounted on either a flat or a curved surface.
2. Run the temperature probe cable into the wireway.

NOTE: The temperature probe cable and the sign's power wires should be run in different conduits.

3. Connect the temperature probe cable to TB2 on the wireway terminal block as shown below. Notice the jumper wire that connects #4 and #5.
4. Close the wireway securely with the screws provided.

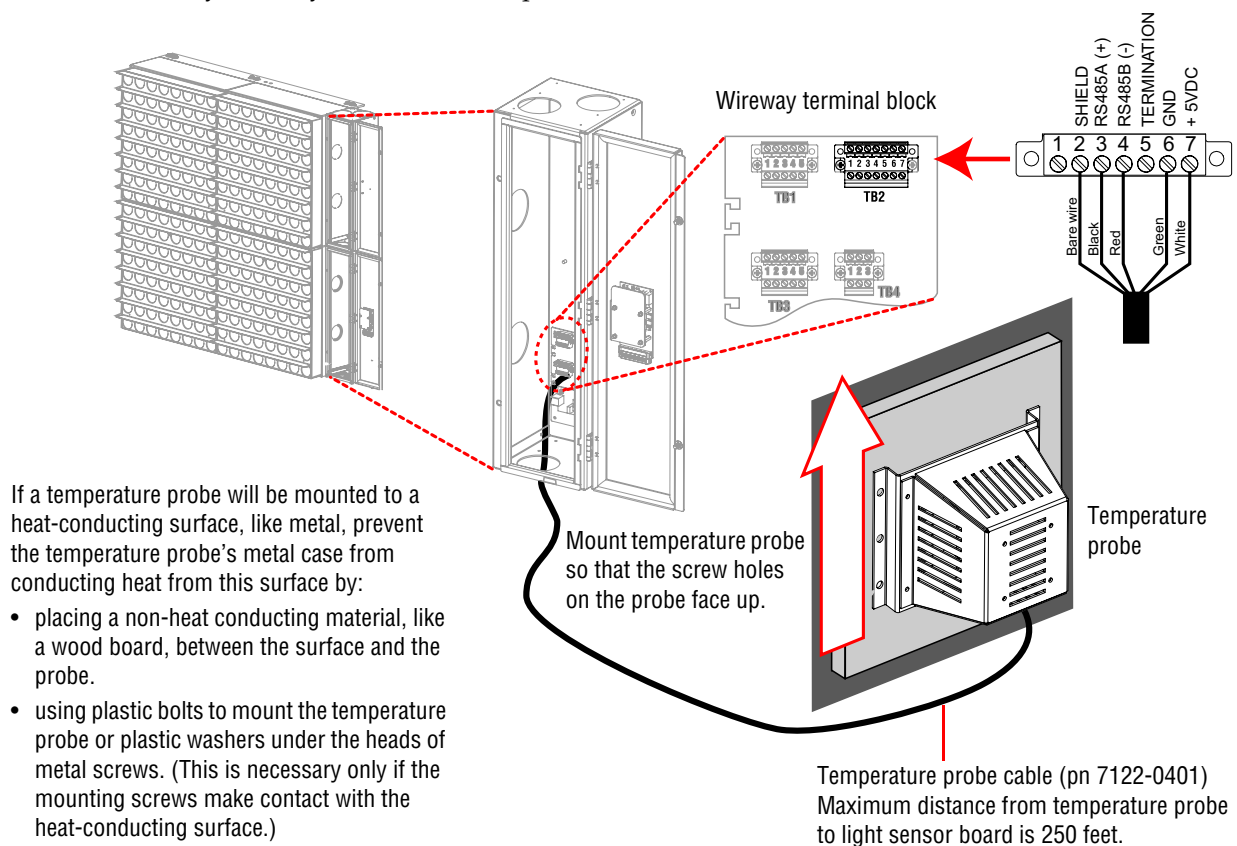

Electrical installation

Electrical installation should only be attempted by a qualified electrician. Electrical connection must comply with all applicable national and local codes.

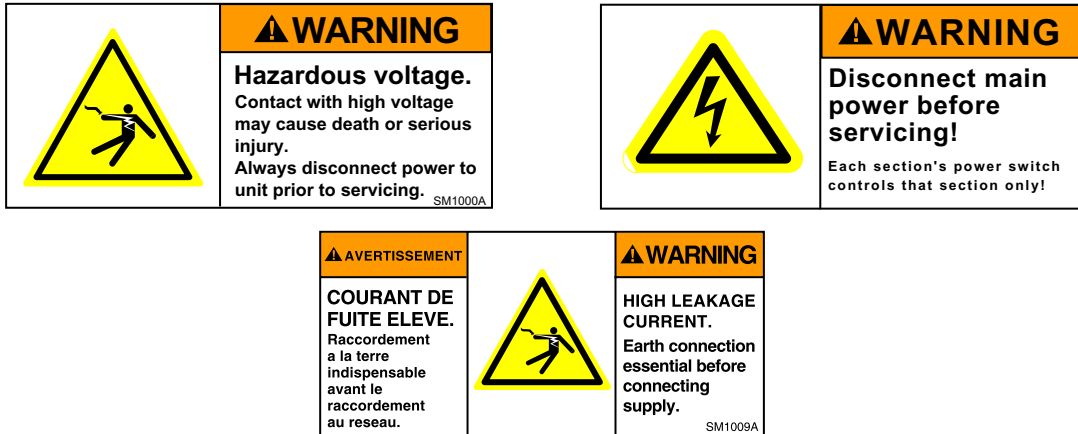

Guidelines for electrical installation

- Inspect all internal sign cabling for proper connection and seating.
- All power wiring must be from circuit breaker-protected lines.
- A two-pole disconnect device must be installed in the building wiring for each branch circuit supplying the sign.
- The sign must be properly grounded according to the applicable codes (for example, NEC Article 250 and 600, and IEEE 1100-1999).
- Run separate conduits for signal wires (for example, RS232, RS485) and for power wires. However, fiber optic wire may be run in the same conduit with power wires.
- All electrical connections must be watertight.
- Use minimum 80° C copper wire only.
Utiliser uniquement un fil en cuivre pouvant supporter 80° C minimum.
- Torque terminals to a minimum of 7 in/lbs and a maximum of 10 in/lbs.
Serrer les bornes à 0,79 N/m minimum, mais pas à plus de 1,13 N/m.

Run power to the sign

1. Use a 5/32-inch hex tool to loosen the hex screws on each of the sign's wireway doors. Then open each wireway door:



5/32-inch hex tool
(pn 6811-7076)



2. On the bottom wireway door, locate the equipment identification label. On this label, find the number and amperage of each power circuit that must be run to the sign (example below):

In this example, two 120V circuits are required to power the sign:

- Circuit #1 = 19.4 amps
- Circuit #2 = 19.4 amps

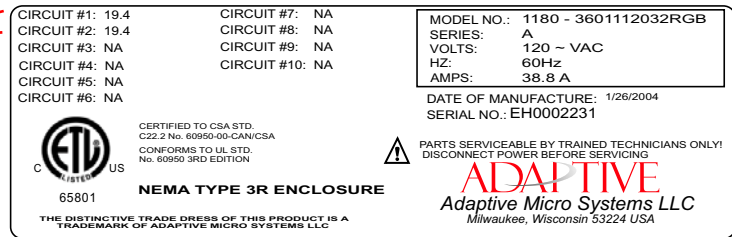

Figure 2: Equipment identification label

3. Run power wires to the wireway using waterproof conduit:

NOTE: A separate conduit must be provided for communication wires. Power and communication wires should never be placed together in the same conduit *unless the communication wires are fiber optic*.

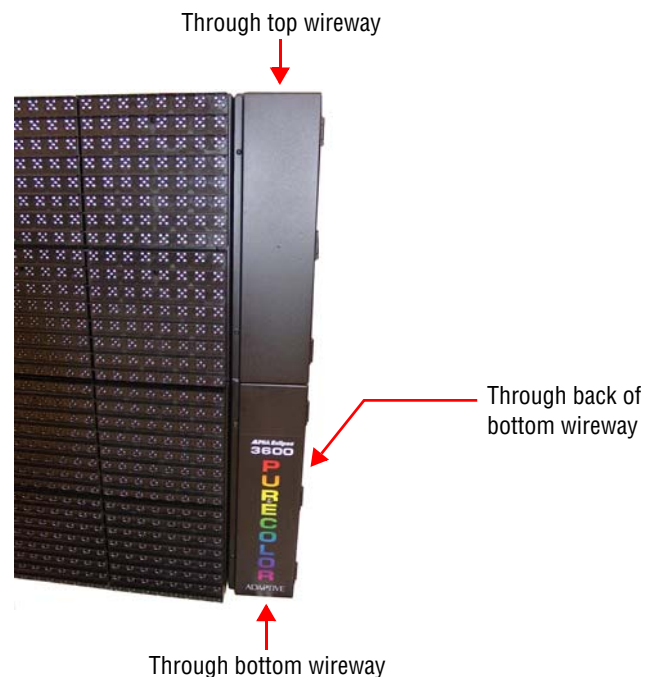

Figure 3: Wireway conduit locations

Adaptive Explains

Why is it necessary to always run *two* conduits to a sign?

It is *not* always necessary. Two conduits are only necessary when communication wire, like RS485 wire, is run to a sign from a computer or from another sign. In these cases, one conduit would contain the sign's power wires and the other conduit the communication wires.

If power and communication wires are put in the same conduit, there is a chance the communication wires might pick up electrical interference from the power wires. For example, when a live power cord is placed next to a stereo speaker wire, the interference from this cord may cause the speaker to hum. In the case of a sign, this same effect could disrupt messages sent to the display.

On the other hand, *fiber optic cable* and power wires can share the same conduit because fiber optic cable is immune to electrical interference.

4. Connect each power circuit to the appropriate wireway power terminal (example below):

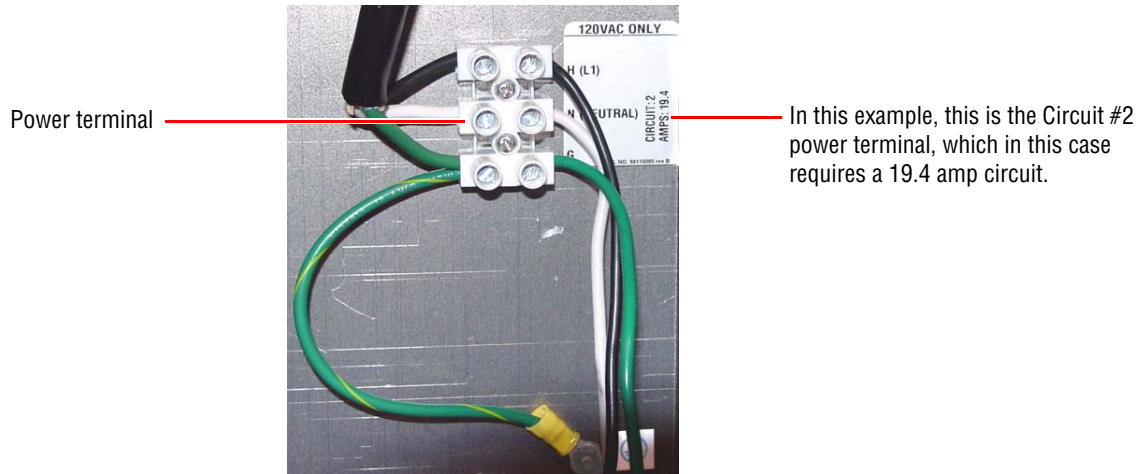

Figure 4: Wireway power terminal

Ground the sign

The sign must be properly grounded in order to provide three types of protection:

- Ground fault protection (see page 19) — The sign must be wired to provide a permanent, low impedance pathway to carry sign ground fault current. This is necessary in order to quickly clear a sign ground fault by opening the power circuit to the sign.

Earth grounding a sign through some type of ground rod bonded to the sign is not sufficient ground fault protection.

- Lightning strike protection (see page 20) — A sign must be earth grounded either through an existing ground rod or separate ground rod(s) bonded to the sign (see NEC Article 250.32).
- Electronic equipment protection (see page 20) — An improperly wired sign could radiate electromagnetic fields (EMF) that may damage or interfere with electronic equipment in or near the sign (see NEC Article 250.6).

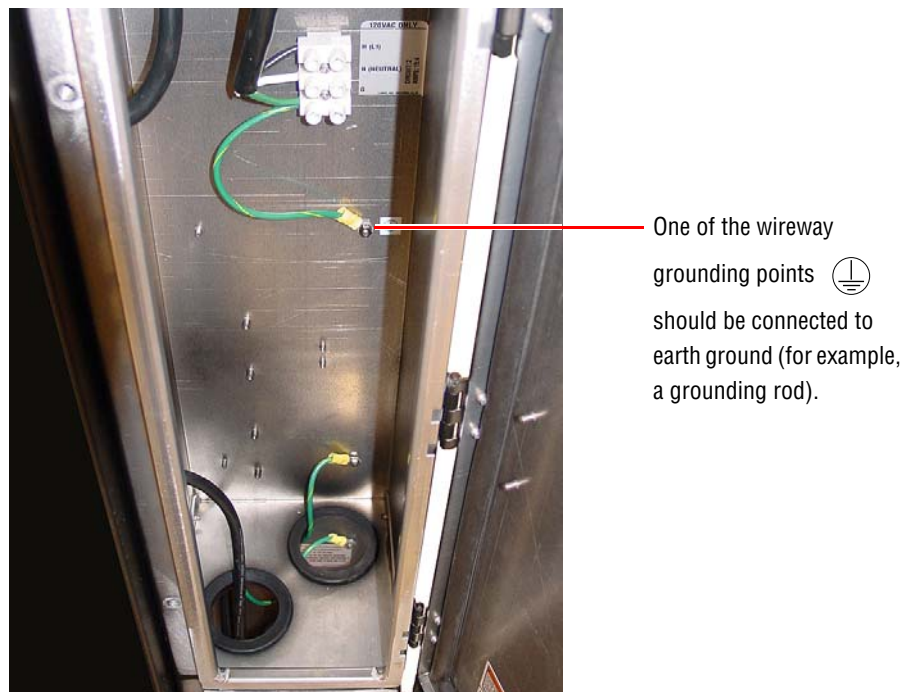
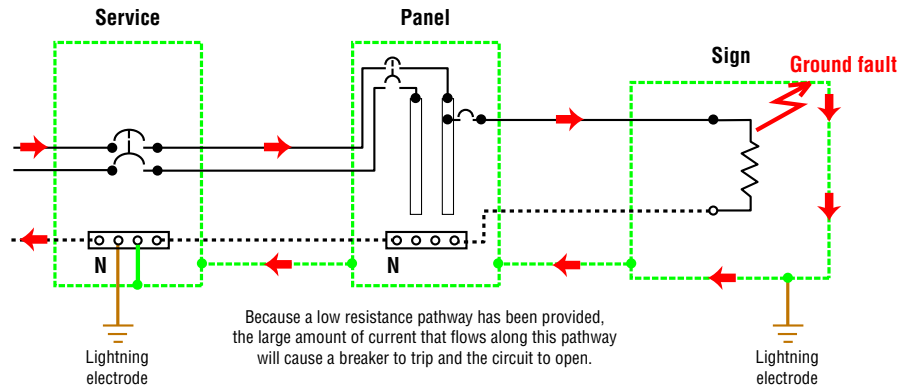

Figure 5: Wireway grounding points

Ground fault protection

Sign with Ground Fault Protection

➔ = ground fault current path



A “ground fault” protected circuit is different from a “ground fault interrupt” protected circuit.

A sign *should* be ground fault protected as shown.

However, a sign *should not* be connected to a ground fault interrupt (GFI) protected circuit.

Sign without Ground Fault Protection

➔ = ground fault current path

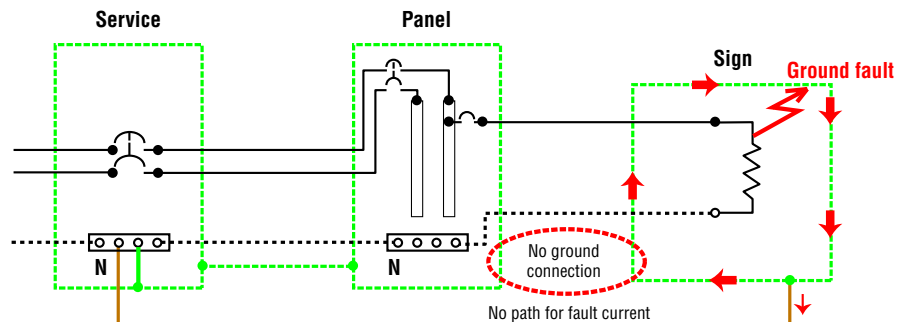

Because of the relatively high resistance of an earth ground, only a small amount of current will flow through the lightning electrode. This small current flow will probably not be enough to open the circuit. As a result, the sign case will become a shock hazard and possibly a fire hazard if the current level is high enough.

Adaptive Explains

What is a ground fault?

It's when a “hot” wire *unintentionally* makes contact with metal, like an electrical outlet box or the case of a sign. If a sign is wired properly, a circuit breaker will trip (or “open”) because too much electrical current is flowing. The ground fault will have to be corrected before the circuit breaker can be closed.

How do you protect against ground faults?

Provide a ground fault current path with so *little* resistance (basically just the resistance of the power wires) that a *huge* amount of current tries to flow. For example, imagine a sign is powered by 120V and is connected to a 20 ampere circuit. If this sign tries to draw more than 20 amps of current, the circuit breaker will trip and the circuit will open. Let's say that this sign is 300 feet away from its power source and that the total resistance of this wire is 0.4 ohms. Using Ohm's Law, the fault current = 120V divided by 0.4 ohms = 300 amps! This amount of current will cause the circuit breaker to open very quickly — removing the shock threat.

Why can't lightning rods be used to protect against ground faults?

A lightning rod (or earth ground) may have too *much* resistance and so not enough current will flow through it to cause a circuit breaker to open. For example, imagine an earth ground has a resistance of 10 ohms, which is low. Using Ohm's Law again, the fault current = 120V divided by 10 ohms = 12 amps. This is not enough current to cause the 20 amp circuit breaker to open. This means the ground fault would not be cleared and dangerous levels of current would be present on the sign's case *and* near the ground rod itself.

Lightning strike protection

A sign bonded to an earth ground has a means of dissipating the high voltage and current from a lightning strike. The resistance of the grounding electrode should be as low as possible. However, damage can still occur to a sign's electronic equipment from lightning voltage transients.

Though some surge protection is incorporated into a sign, to protect a sign from high-voltage lightning transients, surge protectors need to be installed at the panelboards (see NEC Article 280 and 284).

Electronic equipment protection

A common cause for the failure of sensitive electronic equipment is the presence of objectionable current (also called objectionable neutral current) on grounding and bonding paths.

Objectionable neutral current can be caused by:

- Errors in installation wiring
- Improper neutral-to-case bonds (illustrated below)

Objectionable Neutral Current caused by Improper Neutral-to-Case Bond

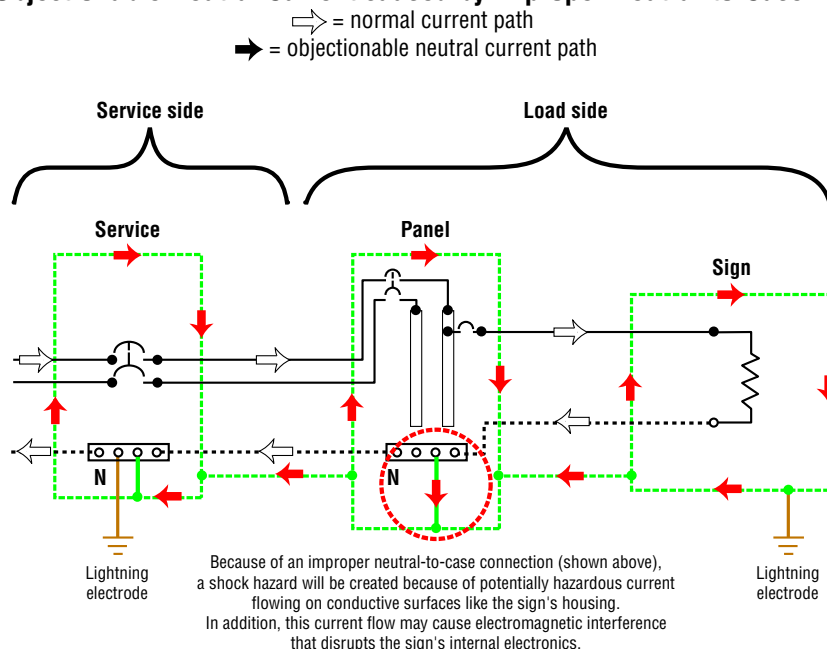

- Equipment-grounding conductor used to carry neutral current — This situation arises when no separate grounding wire is present when connecting power to a sign. NEC Article 250.32(B)(2) *does* permit a neutral-ground bond to be used in a separate structure if all of the following three conditions are met:
 - (1) an equipment grounding conductor is not run with the supply to the structure
 - (2) there are no continuous metallic paths bonded to the grounding system in both structures involved
 - (3) equipment ground-fault protection has not been installed on the common AC service

Adaptive does not recommend using the equipment-grounding conductor to carry neutral current as permitted by NEC 250.32(B)(2) because it creates a potentially hazardous situation. For example, a future installer might connect cabling between the two structures and this could create a dangerous parallel current path.

Adaptive Explains

How can you tell if objectionable neutral current is present?

A true RMS microohm multimeter can be used to measure the voltage difference between the neutral and ground conductors. Though a difference of 0V is ideal, the voltage difference should not exceed 0.5V.

Networking

Up to four AlphaEclipse 3600 signs can be connected together into a network (see “Sign-to-sign connections” on page 21).

Also, in order to display messages, a sign must be connected to a computer that is running AlphaNET software (see “Computer-to-sign connections” on page 25).

Sign-to-sign connections

NOTE: When two or more signs are connected together, they must be properly terminated. See “RS485 termination” on page 34.

Two or more signs can be set up as either

- Master/Master signs (page 22) — two to four signs that can display a different message. While the same message could be sent to both Master signs, the messages may not appear at *exactly* the same time on the signs. In order to display the temperature in Master/Master signs, a temperature probe must be connected to *each* of the signs.
- Master/Secondary Master (page 23) — identical to signs connected as Master/Master except for temperature display. Signs connected as Master/Secondary Master only require that a single temperature probe connected to *just* the Master sign. This is the main advantage of Master/Secondary Master sign connection.
- Master/Slave signs (page 24) — all these signs display *the same message at the same time*. In this setup, one sign is configured as the Master and all the others as Slave signs.

Adaptive Explains

Does it matter if signs are set up as Master/Master, Master/Secondary Master, or Master/Slave?

The most important difference between Master/Master and Master/Slave signs is that Master/Slave signs *all* display *the same message at the exact same time*. On the other hand, signs configured as Master/Master or Master/Secondary Master allow you to display a *different* message on each of the signs.

However, to display the temperature on signs, use either Master/Secondary Master or Master/Slave mode because only one temperature probe is required. (In Master/Master mode, a temperature probe is needed for *each* sign.)

How are signs set up to be Master/Master, Master/Secondary Master, or Master/Slave?

Signs are configured at the factory.

Is there any way to tell if a sign is a Master, a Secondary Master, or a Slave sign by just looking at it?

Probably not without turning the sign off and then on again. When you do this, the word “Master”, “Sec-Master” or “Slave” will appear in the sign’s startup messages.

Also, if you are able to see the back of the sign’s wireway, there is a label that indicates how the sign is configured.

Master/Master sign wiring

AlphaEclipse 3600

Master / Master sign connection

Signs connected as Master/Master can each display a unique message — unlike Master/Slave signs in which both all the signs always display the same message at the same time. In a Master/Master sign pair, a message can be displayed on Master sign #1 by sending the message to serial address 1, or displayed on Master sign #2 by sending the message to serial address 2. Also, a message can be displayed on all Master signs by broadcasting the message to serial address 0.

Overview

MASTER SIGN #1 - SERIAL ADDRESS 1

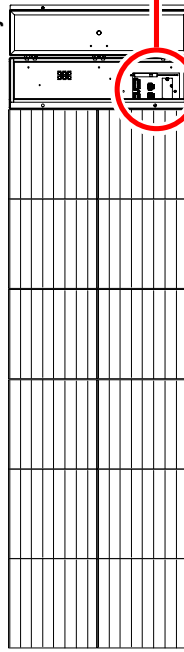

Wireway terminal block pinouts

SERIAL I/O	CUSTOMER CONNECTION
2	SHIELD
3	RS485+
4	RS485-
5	TERM
TB1	MAIN 485
2	SHIELD
3	RS485+
4	RS485-
5	TERM
TB2	TEMP PROBE
6	GND
7	+5VDC
2	SHIELD
3	RS485+
4	RS485-
5	TERM
TB3	COM3
2	SYNC COM
3	MAIN 232
1	RS232 TxD
2	RS232 RxD
3	SGL GND
TB4	(COM. ACCESSORY)

NOTE: TB1 - TB4 PLUGS ARE KEYS. DO NOT MIX!

"TB" = Terminal Block

DRAWING REVISION 6

Wiring

MASTER SIGN #2 - SERIAL ADDRESS 2

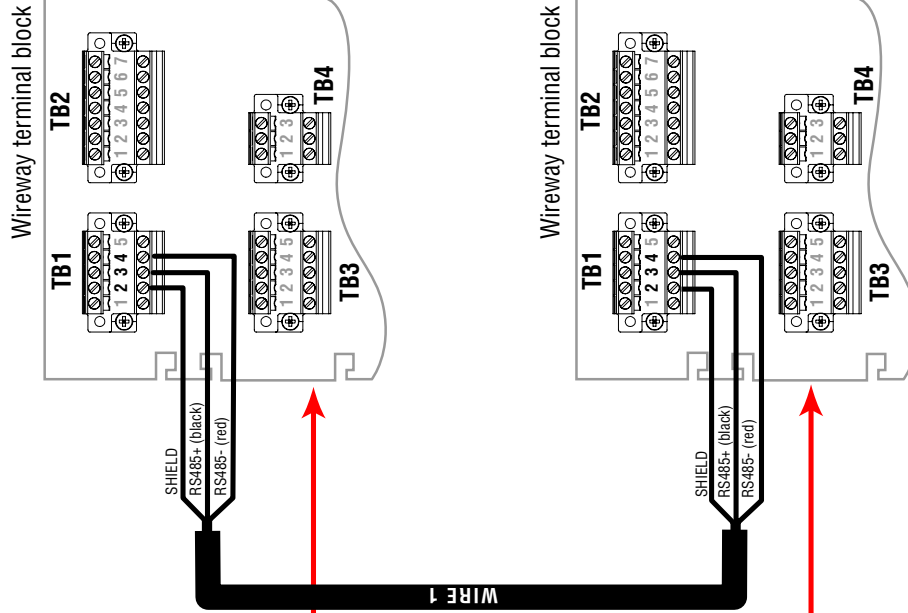
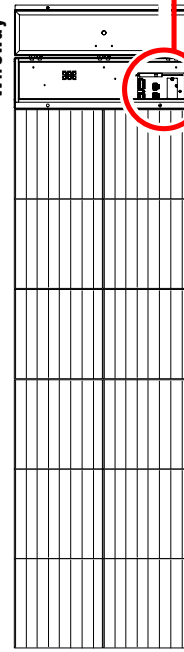

Master/Secondary Master sign wiring

AlphaEclipse 3600

Master / Secondary Master sign connection

Overview

Signs connected as Master/Secondary Master can each display a unique message — unlike Master/Slave signs in which all the signs always display the same message at the same time. In a Master/Secondary Master pair, a message can be displayed on Master sign #1 by sending a message to serial address 1, or displayed on Secondary Master sign #2 by sending a message to serial address 2. Also, a message can be displayed on all the signs by broadcasting the message to serial address 0.

Wiring

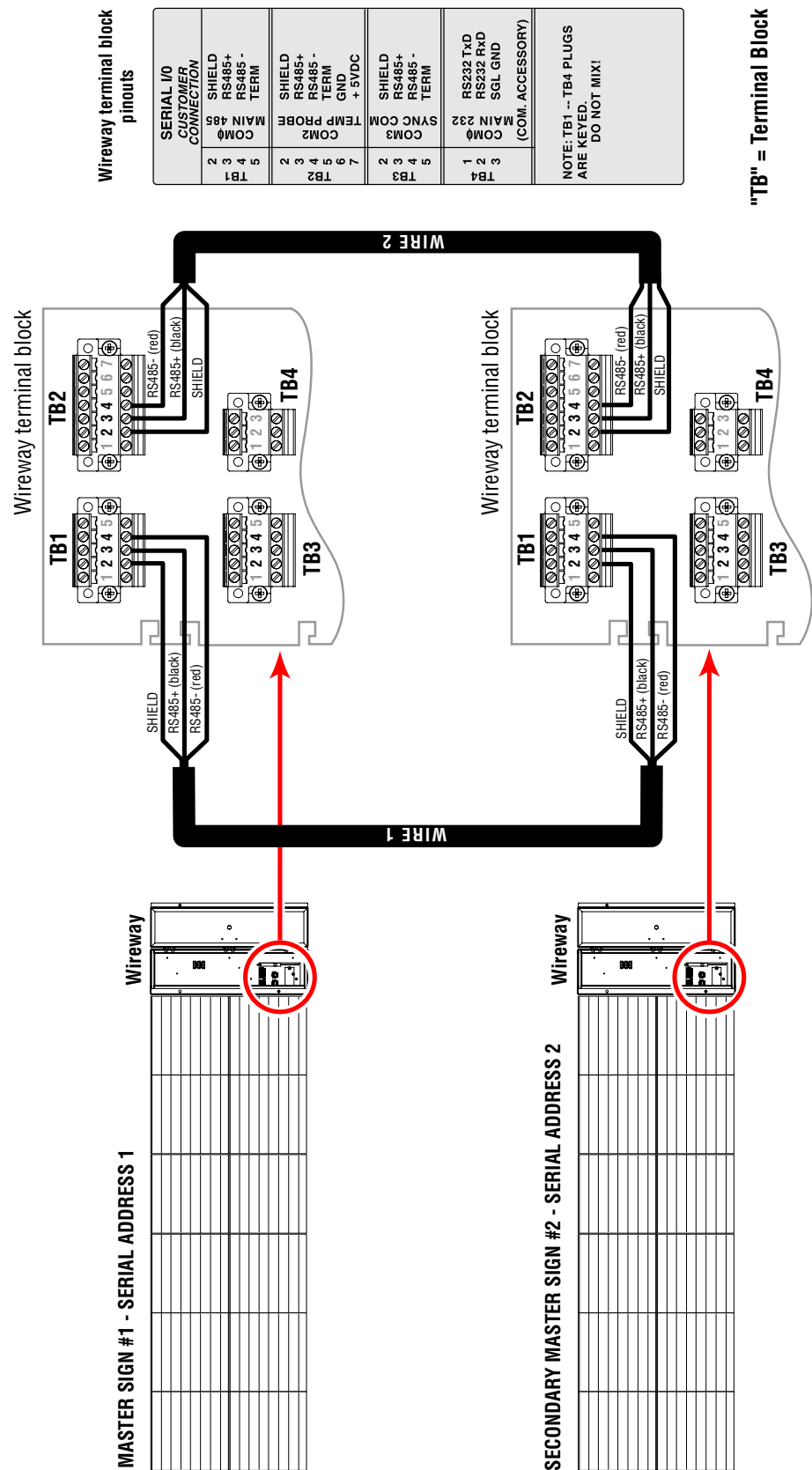

"TB" = Terminal Block

DRAWING REVISION 4

Master/Slave sign wiring

AlphaEclipse 3600

Master / Slave sign connection

Overview

Signs connected as Master/Slave always display the same message at the same time — unlike Master/Master signs in which unique messages can be displayed on each sign. For Master/Slave signs, all messages should be sent to either serial address 0 or to all the sign's addresses (in the example below, address 1 and 2).

Wiring

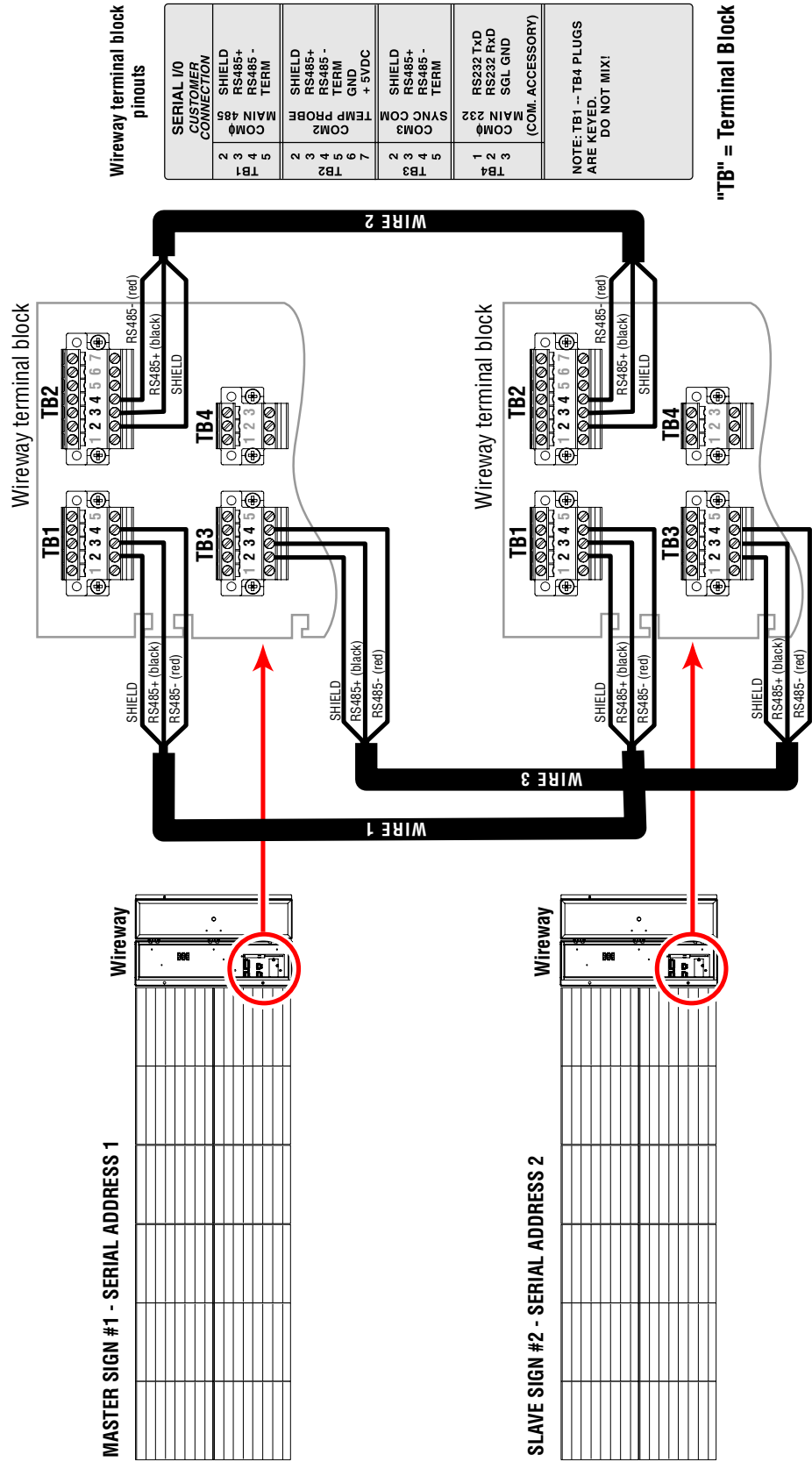

DRAWING REVISION 4

Computer-to-sign connections

In order to display messages, a sign must be connected to a computer that is running AlphaNET software. (This computer is referred to as the “messaging computer”.)

There are a number of ways to connect the messaging computer to a sign:

- RS485 wire (page 26) — using RS485 outdoor wire (pn 7124-0203), a sign can be wired to a computer that could be up to 4000 feet away from the sign.

Ordinary wire, phone wire, CAT 5 wire, and so on should NOT be used in place of Adaptive’s RS485 outdoor wire.

- Modem (page 27) — by placing a modem inside a sign (factory installed) and attaching another modem to the messaging computer, messages are sent to a sign through ordinary phone lines.
- Fiber optic (page 28) — using a fiber optic mini-modem inside a sign (factory installed) and another mini-modem connected to the messaging computer, a sign can be connected to a computer that could be up to 2 miles away from the sign. Fiber optic cable is immune to electrical interference so the cable can be placed in the same conduit as the power wires.
- Wireless transceiver (page 29) — for this option, one wireless transceiver is placed inside the sign (called the “Receive” unit which is factory installed) and another transceiver (called the “Master”) is connected to the messaging computer. Wireless transceivers can connect to a sign up to 2 miles away. (Actual distance can vary greatly depending on the local environment, obstructions, electrical interference, and so on.)

RS485 wire computer-to-sign connection

AlphaEclipse 3600

RS485 wire computer-to-sign connection

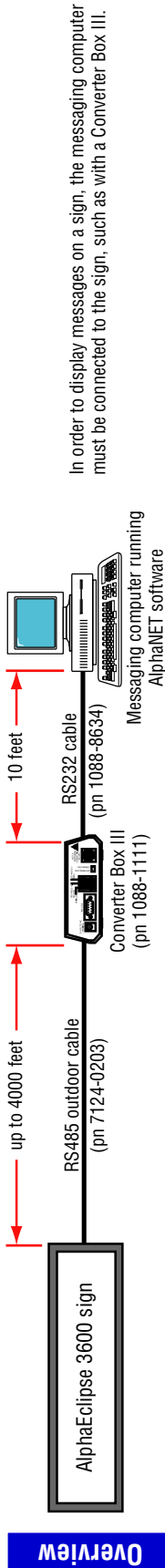

Converter Box III (pn 1088-1111)

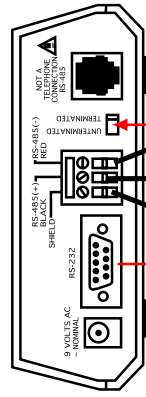

To messaging computer

RS232 cable (pn 1088-8634)

SERIAL I/O	CUSTOMER CONNECTION
3	SHIELD
2	RS485+
4	RS485-
5	MAIN 485 TERM
1	TB1
2	SHIELD
3	RS485+
4	RS485-
5	TEMP GND
6	TEMP PROBE
7	+ 5VDC
2	SHIELD
3	RS485+
4	RS485-
5	MAIN 232
1	TB4
2	RS232 TXD
3	RS232 RXD
4	SGL GND
5	COM. ACCESSORY

NOTE: TB1 -- TB4 PLUGS ARE KEYPED. DO NOT MIX!

Wireway terminal block pinouts

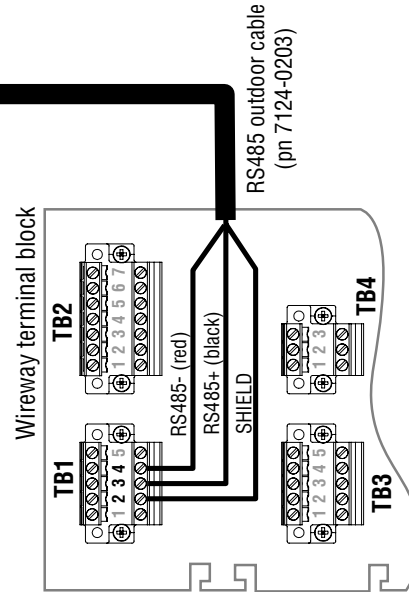

"TB" = Terminal Block

AlphaEclipse 3600 sign

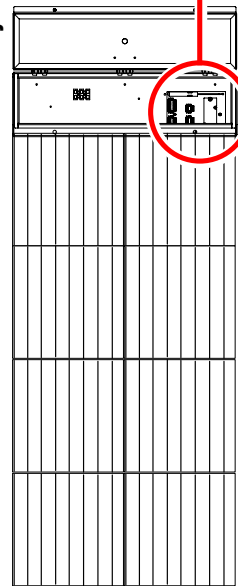

Wiring

Modem computer-to-sign connection

AlphaEclipse 3600

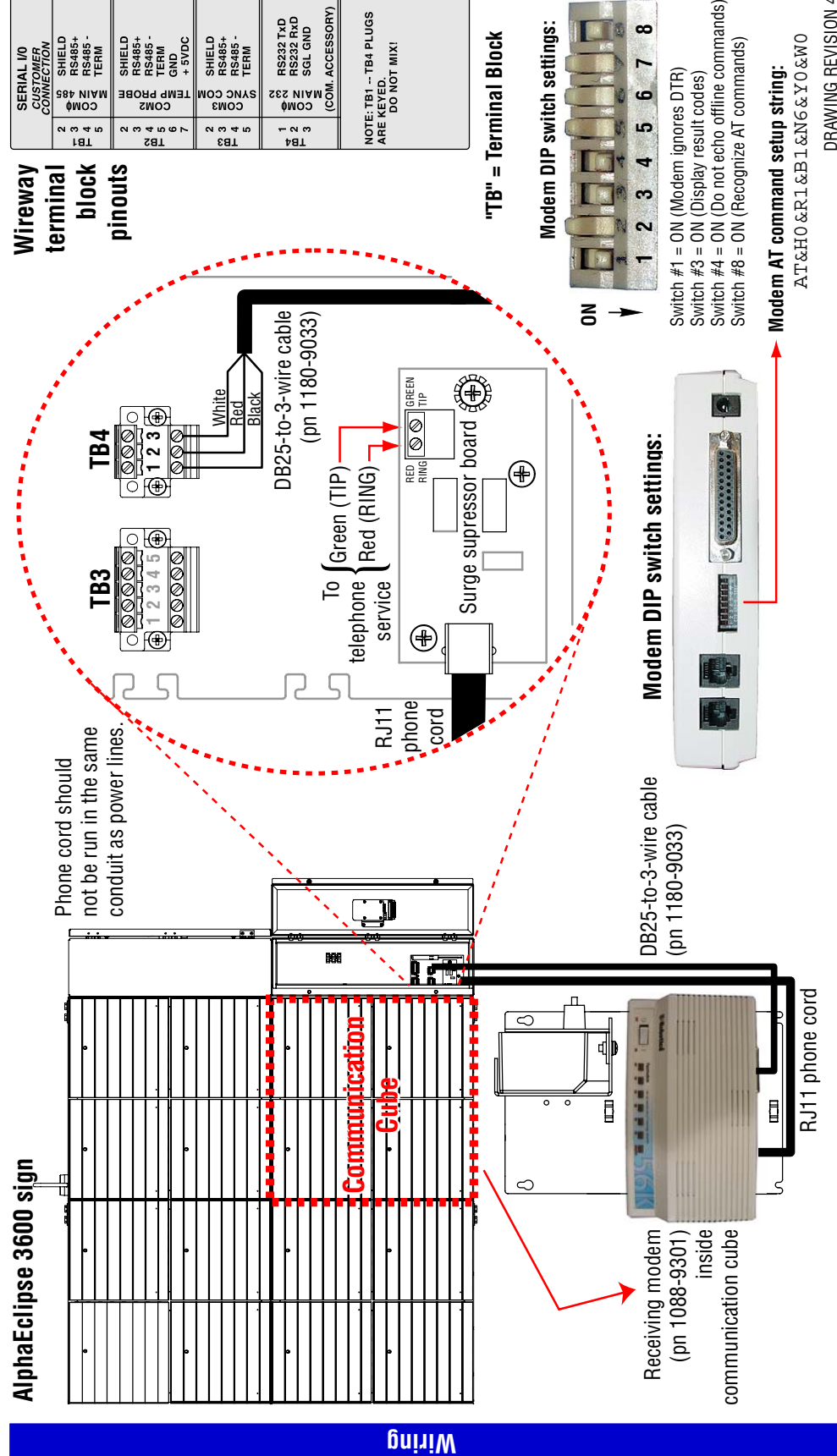
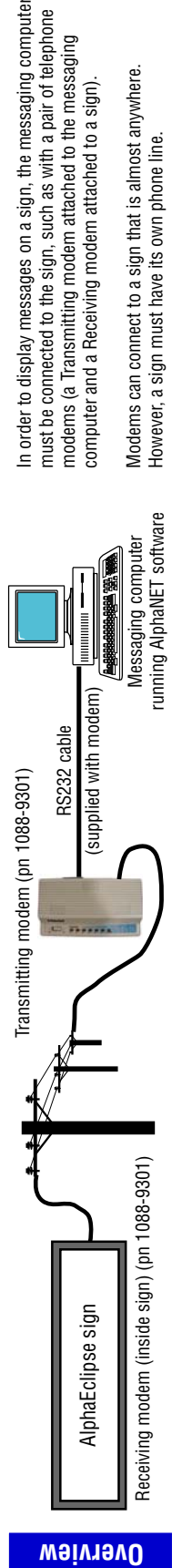

Fiber optic computer-to-sign connection

Fiber optic computer-to-sign connection

AlphaEclipse 3600

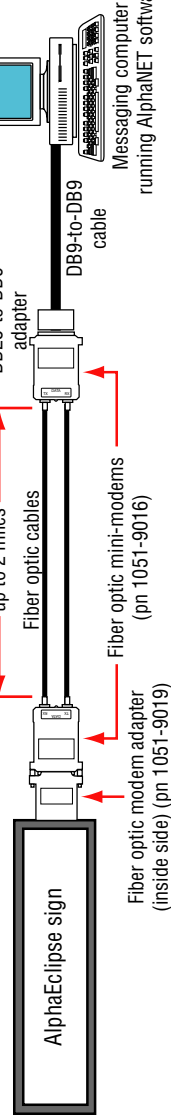

In order to display messages on a sign, the messaging computer must be connected to the sign, such as with fiber optic modems. Fiber optic modems allow the messaging computer to connect to a sign up to 2 miles away from the computer. The fiber optic modems send data to a sign over an optical RS232 connection.

Overview

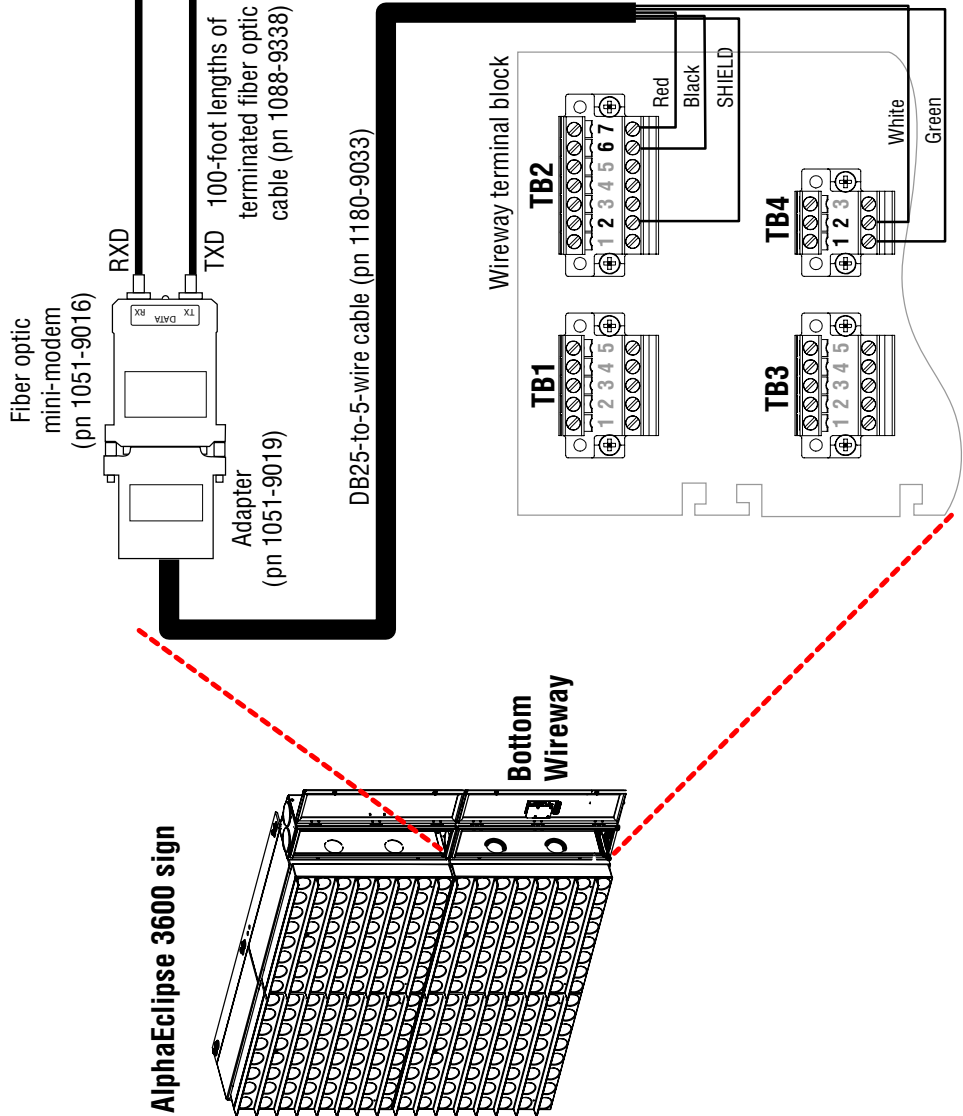

AlphaEclipse 3600 sign

Bottom Wireway

DB25-to-5-wire cable (pn 1180-9033)

Wireway terminal block pinouts

SERIAL I/O	CUSTOMER CONNECTION
2	SHIELD
3	RS485+ / RS485- TERM
4	MAIN 485
5	COM2
6	TEMP PROBE
7	GND +5VDC
2	SHIELD
3	RS485+ / RS485- TERM
4	COM3
5	SYNC COM
6	RS232 TXD
7	RS232 RXD
8	SGL GND
9	(COMM. ACCESSORY)

"TB" = Terminal Block

NOTE: TB1 - TB4 PLUGS ARE KEVED. DO NOT MIX!

Wiring

DRAWING REVISION 5

Wireless transceiver computer-to-sign connection (Locus)

AlphaEclipse 3600

Wireless computer-to-sign connection (Locus 2.4GHz transceiver)

In order to display messages on a sign, the messaging computer must be connected to the sign, such as with a pair of wireless transceivers (a Master transceiver attached to the messaging computer and a Receive transceiver attached to a sign).

Wireless transceivers can connect to a sign that is up to 2 miles away. (Actual distance depends on the local environment, obstructions, electrical interference, and so on.)



Overview

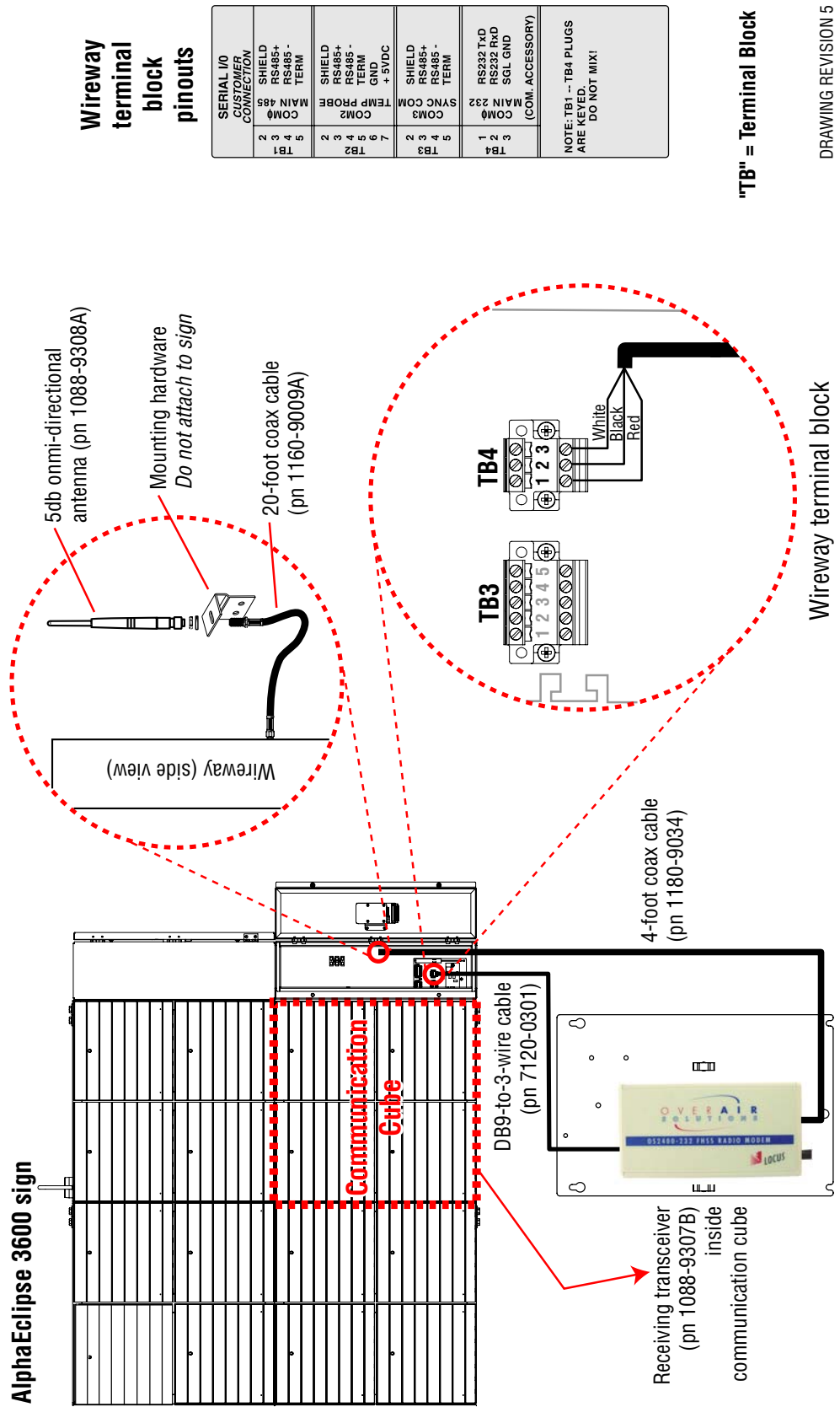

Wiring

SERIAL I/O	CUSTOMER CONNECTION
2	SHIELD
3	RS485+
4	RS485 -
5	TERM
TB1	MAIN 485
2	SHIELD
3	TEMP PROBE
4	RS485+
5	RS485 -
6	TERM
7	GND + 5VDC
2	SHIELD
3	COM3
4	RS485+
5	RS485 -
TB3	SYNC COM
1	RS232TXD
2	RS232RXD
3	SGL GND
4	MAIN 232
5	COM. ACCESSORY)

NOTE: TB1 -- TB4 PLUGS ARE KEYPED. DO NOT MIX!

"TB" = Terminal Block

DRAWING REVISION 5

Wireless transceiver computer-to-sign connection (Alpha RF900)

AlphaEclipse 3600

Wireless connection (Alpha RF900 900MHz transceiver)

In order to display messages on a sign, the messaging computer must be connected to the sign, such as with a pair of wireless transceivers (a server transceiver attached to the messaging computer and a client transceiver attached to a sign).

Alpha RF900 transceivers have an indoor transmission range of 300 to 500 feet and an outdoor range of 3500 feet line-of-site.



Overview

AlphaEclipse 3600 sign

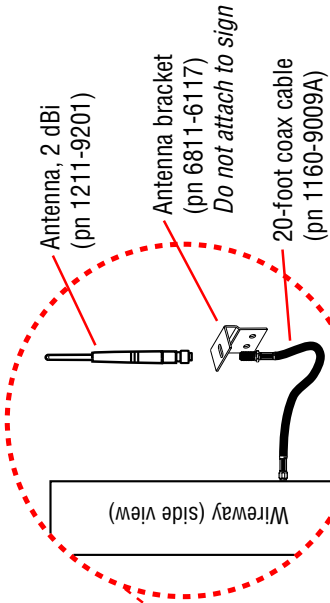
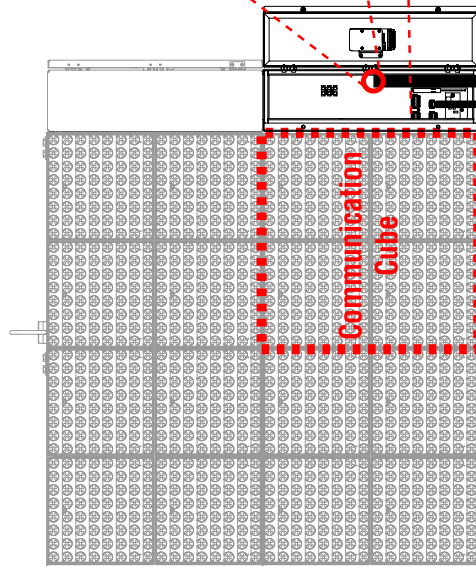

Wireway terminal block pinouts

SERIAL I/O	CUSTOMER CONNECTION
2	SHIELD
3	RS485+
4	RS485-
5	MAIN 485 TERM
TB1	
2	SHIELD
3	RS485+
4	RS485-
5	TEMP PROBE
6	TERM
7	GND + 5VDC
TB2	
2	SHIELD
3	RS485+
4	RS485-
5	TERM
TB3	
1	RS232 TxD
2	RS232 RxD
3	SGL GND
TB4	
1	RS232 TxD
2	RS232 RxD
3	SGL GND
TB4	
	(COM. ACCESSORY)

NOTE: TB1 ... TB4 PLUGS ARE KEV-10 MIXI DO NOT MIXI

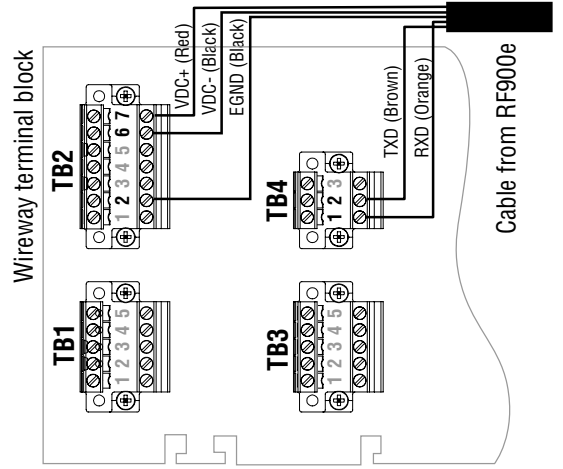

"TB" = Terminal Block

DRAWING REVISION 3

Wiring

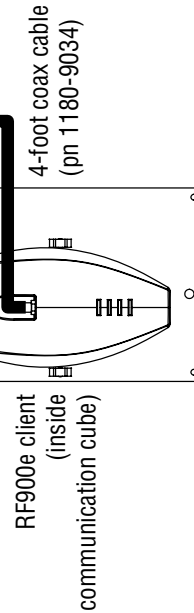

Appendix

Serial address of a sign

The serial address of a sign is a number used to identify one sign from another when messages are sent.

Each AlphaEclipse is factory programmed with a serial address. Though a sign's address can be changed, it is usually not necessary or desirable to do so.

There are two ways to determine a sign's serial address:

- **METHOD 1:** Look on the back of the sign's bottom wireway — a label similar to the following will identify a sign's serial address and whether the sign is set up as a Master, Secondary Master, or a Slave sign:

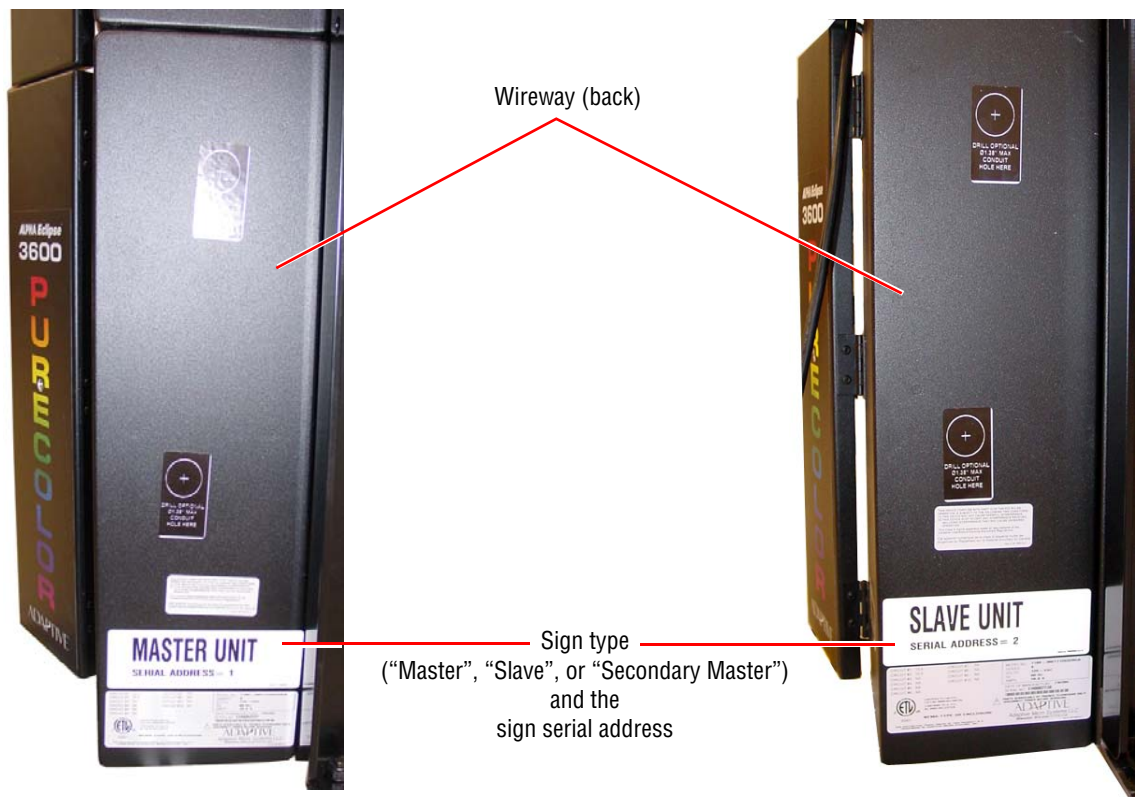

- **METHOD 2:** Remove power to the sign and then reapply power — a series of startup messages will appear on the sign. One of these messages will identify the sign's serial address and another whether a sign is a Master, Secondary Master, or a Slave sign.

Opening a sign

How to open a sign from the back

Ordinary, controller board, and communication cubes (see "Internal view" on page 8) are all opened from the back in the same way

1. Remove power from the sign.

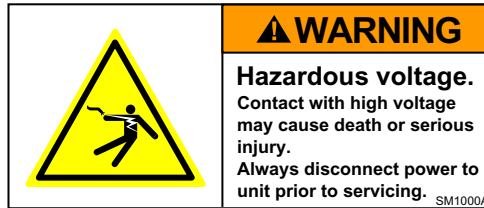

2. Use a 5/32-inch hex tool to loosen the two screws on the back a cube:

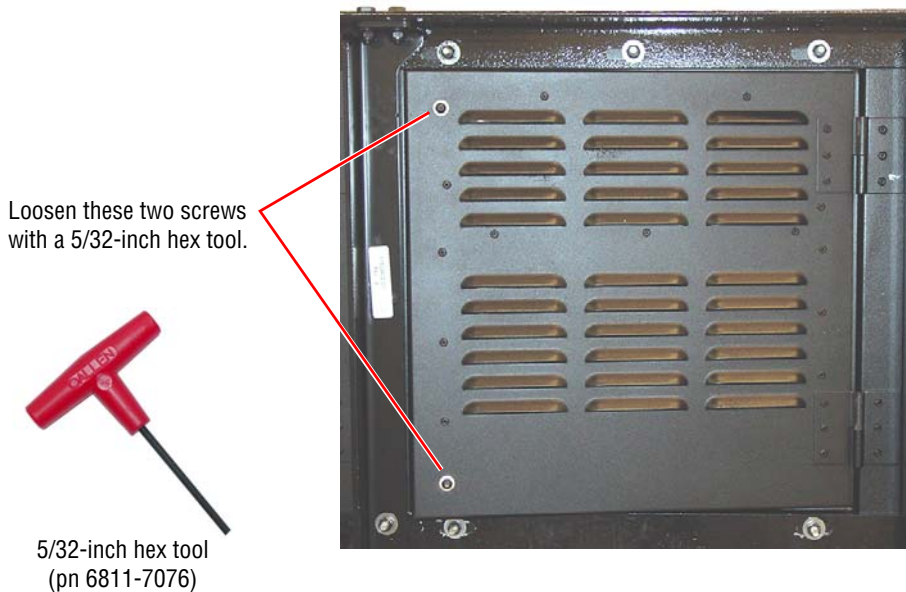

3. Open the cube door:



There are three types of sign cubes (see "Internal view" on page 8):

- ordinary
- controller (There is only one of these in a sign.)
- communication (There is only one of these in a sign.)

Shown on the left is a sign's controller cube.

Open a sign door slowly. Otherwise some of the cables attached to the door may snap off.

How to open a sign from the front

If it is not possible to open the back of the cube, remove the four LED modules from the front of the cube:

A LED module *must* be put back into the *same* location from where it was removed.

1. Remove power from the sign.

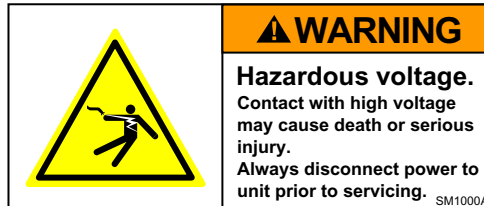

2. Locate the hex tool access hole in the LED module that is to be removed:

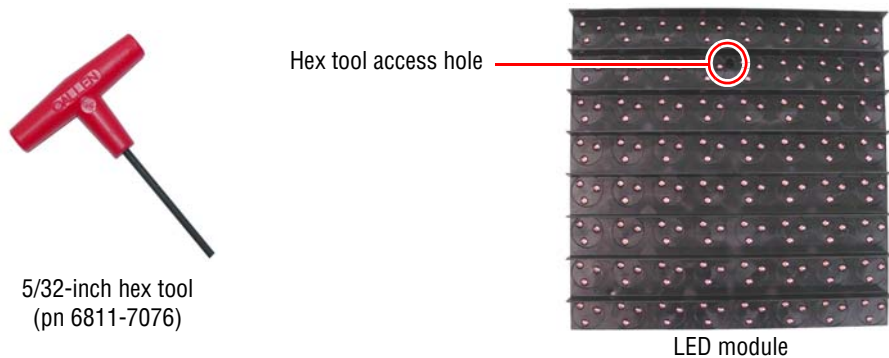

3. Insert the hex tool into the LED cube access hole. Turn counterclockwise to open the latch. Then lift the LED module up and pull it back and out of the LED module:

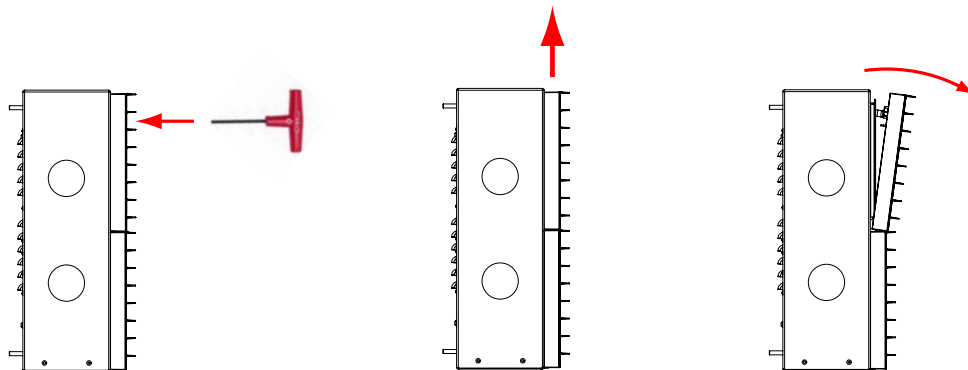

4. Unhook the data and the power cables from the back of the LED module. Then remove the LED module from the cube:

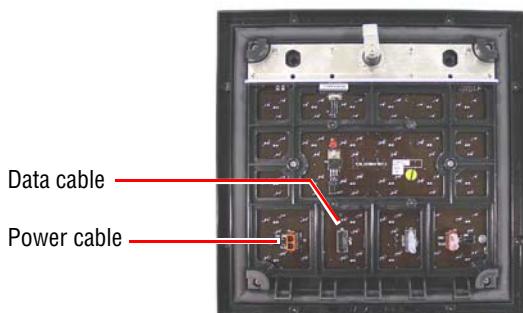

If more than one LED module is removed, keep track of the location of each module. Each LED module must be put back in its *original* location.

Also, each LED module has its own data and power cable.

The drawing on the right shows how LED modules are named.

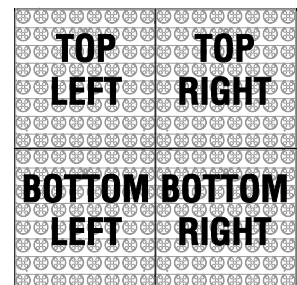

FRONT VIEW

RS485 termination

What is RS485 termination?

When signs are connected together, it is necessary to terminate each end of the network. This is necessary to make sure that the signs communicate with each other.

If signs are *not* correctly terminated, messages could be displayed improperly.

When is termination used?

RULE: Terminate the first and last sign in a network:

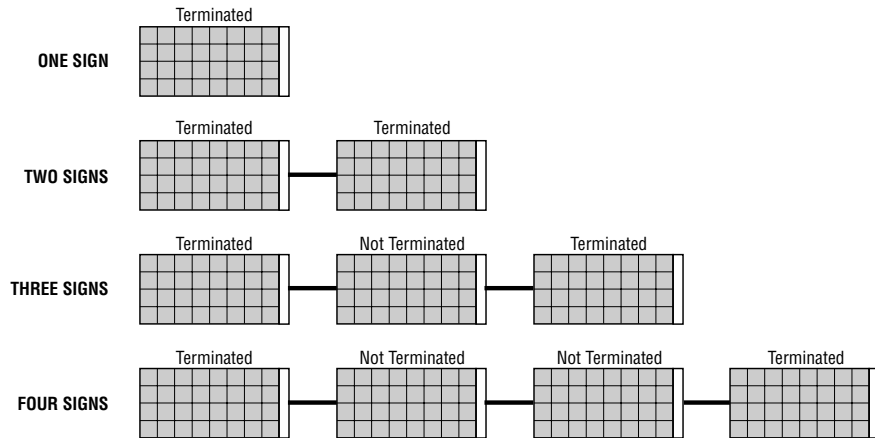

RULE: If a Converter Box III is used, treat the converter box as if it were a sign:

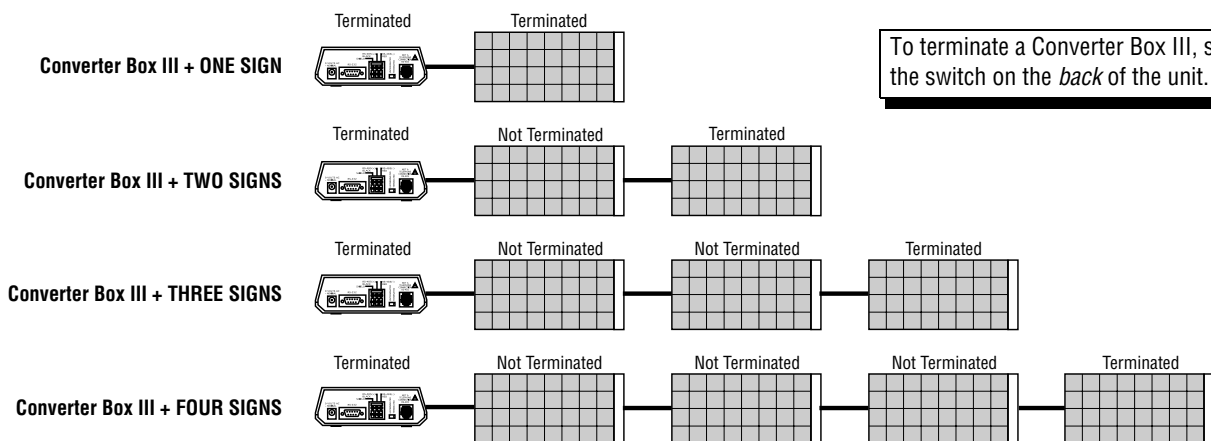

How to terminate a sign

1. Remove power from the sign.



2. Locate the sign's controller cube (see "Internal view" on page 8).
3. On the sign that requires termination, open the controller cube using one of these two methods:
 - Open the cube *from the back* (see "How to open a sign from the back" on page 32).
 - Open the cube *from the front* (see "How to open a sign from the front" on page 33).
4. Attach a wire jumper to connector P14 terminals #4 and #5 on the sign's controller board:

NOTE: To access the controller board, open the back of the cube (as shown below), or remove all four LED modules from the front of the cube (see "Opening a sign" on page 32).

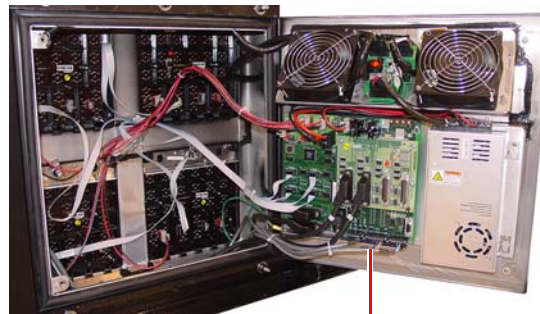

Controller board cube
(see "Internal view" on page 8 for the location of this cube in a sign)

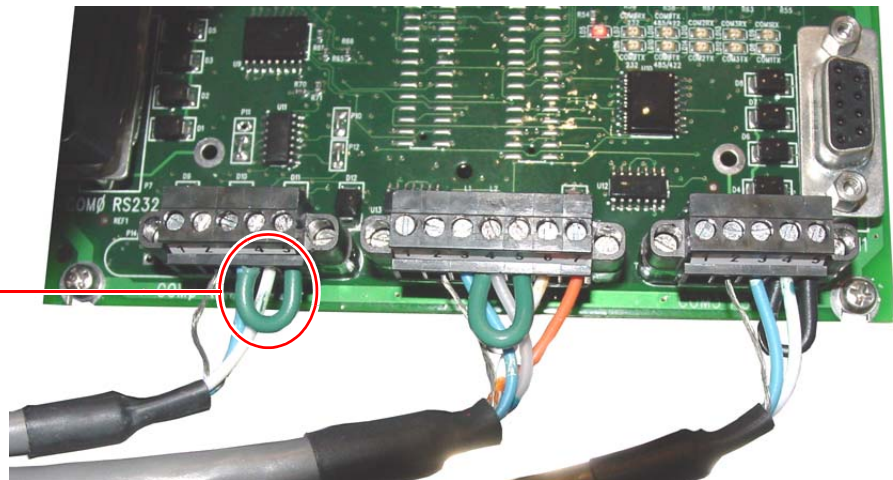

Termination jumper wire
Attach a wire to terminals #4 and #5 on connector P14 on the controller board.

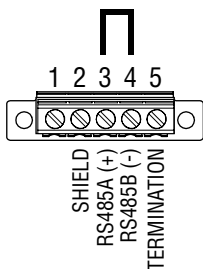

P14 COM0 RS485/422

Controller board

Figure 6: Termination jumper wire

How to remove termination from a sign

1. Remove power from the sign.



2. Locate the sign's controller cube (see "Internal view" on page 8).
3. On the sign that needs termination removed, open the controller cube using one of these two methods:
 - Open the cube *from the back* (see "How to open a sign from the back" on page 32).
 - Open the cube *from the front* (see "How to open a sign from the front" on page 33).
4. Remove the wire jumper that connects terminals #4 and #5 on connector P14 on the sign's controller board (see Figure 6 on page 35).

NOTE: To access the controller board, open the back of the cube, or remove all four LED modules from the front of the cube (see "Opening a sign" on page 32).